

J:\2008 PROJECTS\34801\700CADD\750AET\ROADWAY\PF_301AET_001.DGN

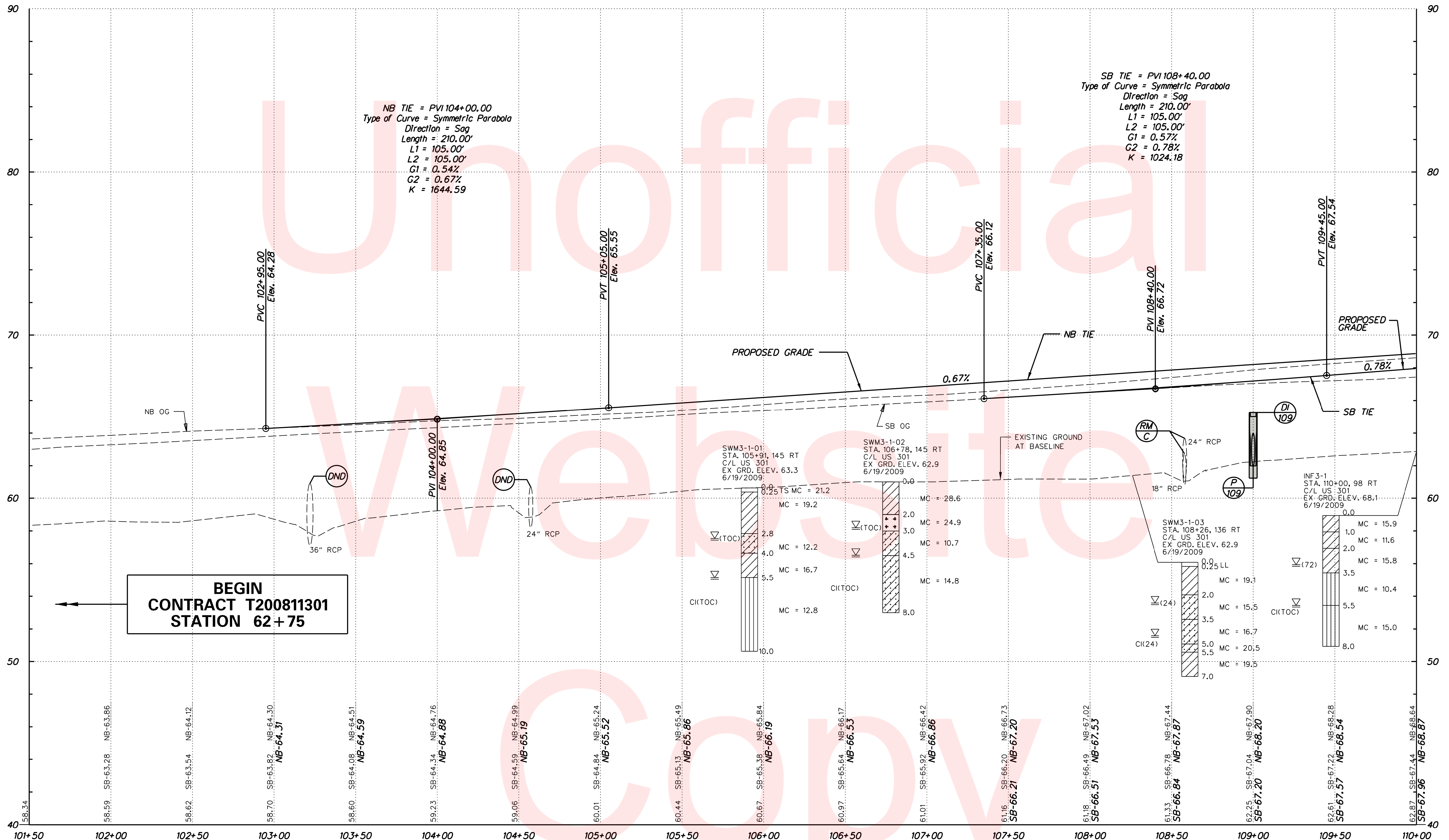

BEGIN CONTRACT T200811301 STATION 62+75

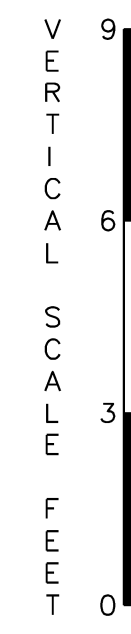
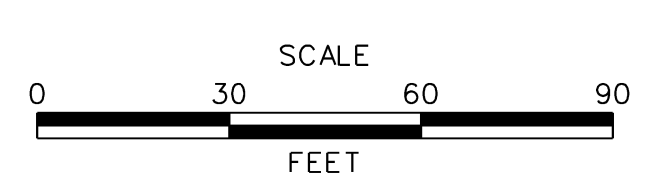

ADDENDUMS / REVISIONS	

US 301 MARYLAND STATE LINE TO LEVELS ROAD

CONTRACT T200811301	BRIDGE NO.
COUNTY CECIL	DESIGNED BY: MFM
	CHECKED BY: SKH

PROFILES

PF-01	
SHEET NO.	104
TOTAL SHTS.	850

J:\2008 PROJECTS\34801\700ADD\750AET\ROADWAY\PF_301AET_002.DGN

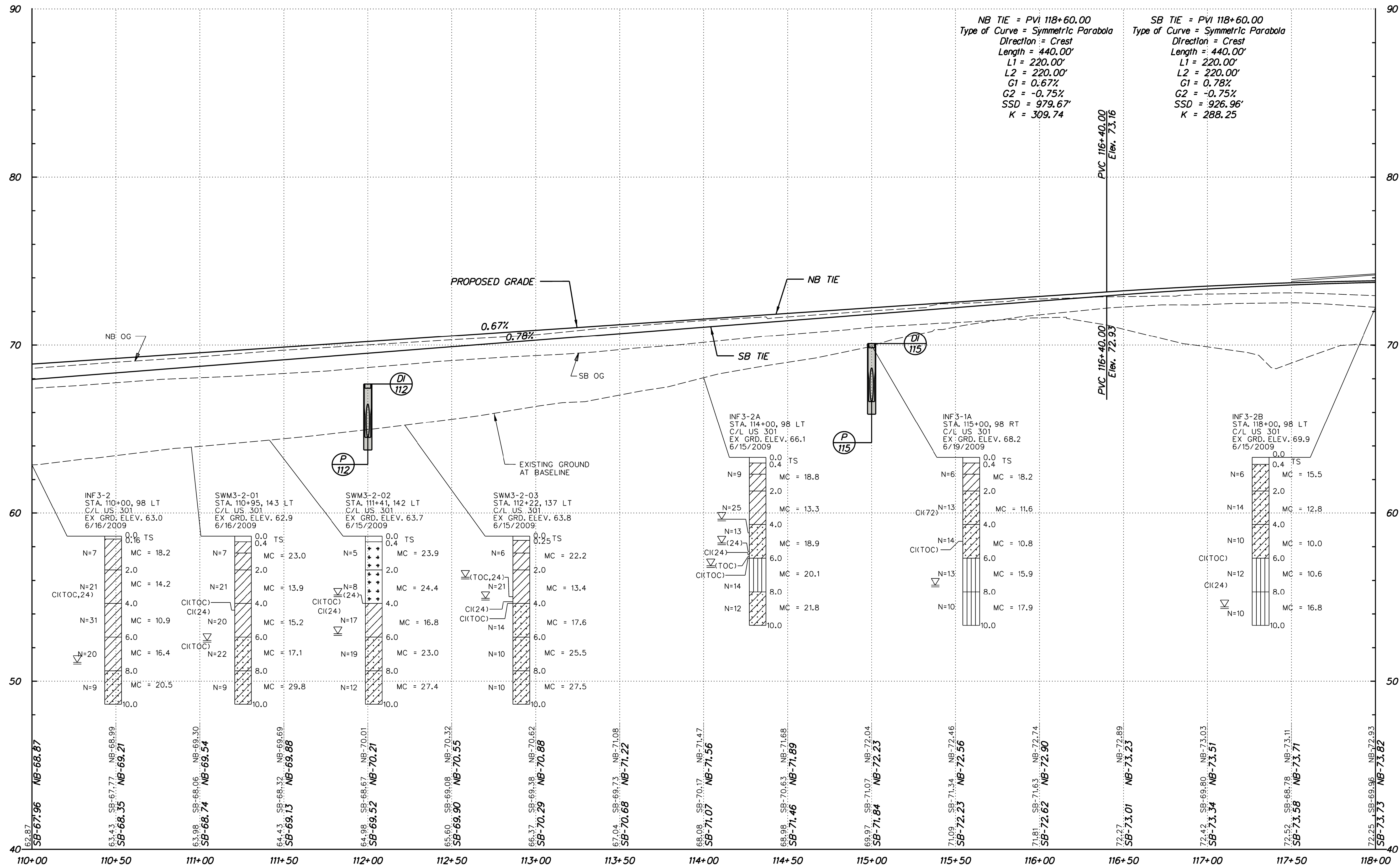

US 301

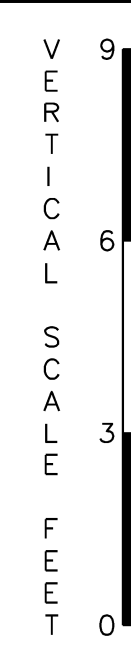

PF-02



ADDENDUMS / REVISIONS	

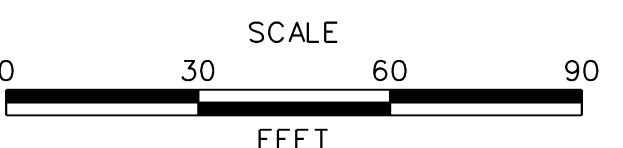

US 301
 MARYLAND STATE LINE
 TO LEVELS ROAD

CONTRACT T200811301	BRIDGE NO.
COUNTY CECIL	DESIGNED BY: MFM
	CHECKED BY: SKH

PROFILES

SHEET NO. 105
TOTAL SHTS. 850

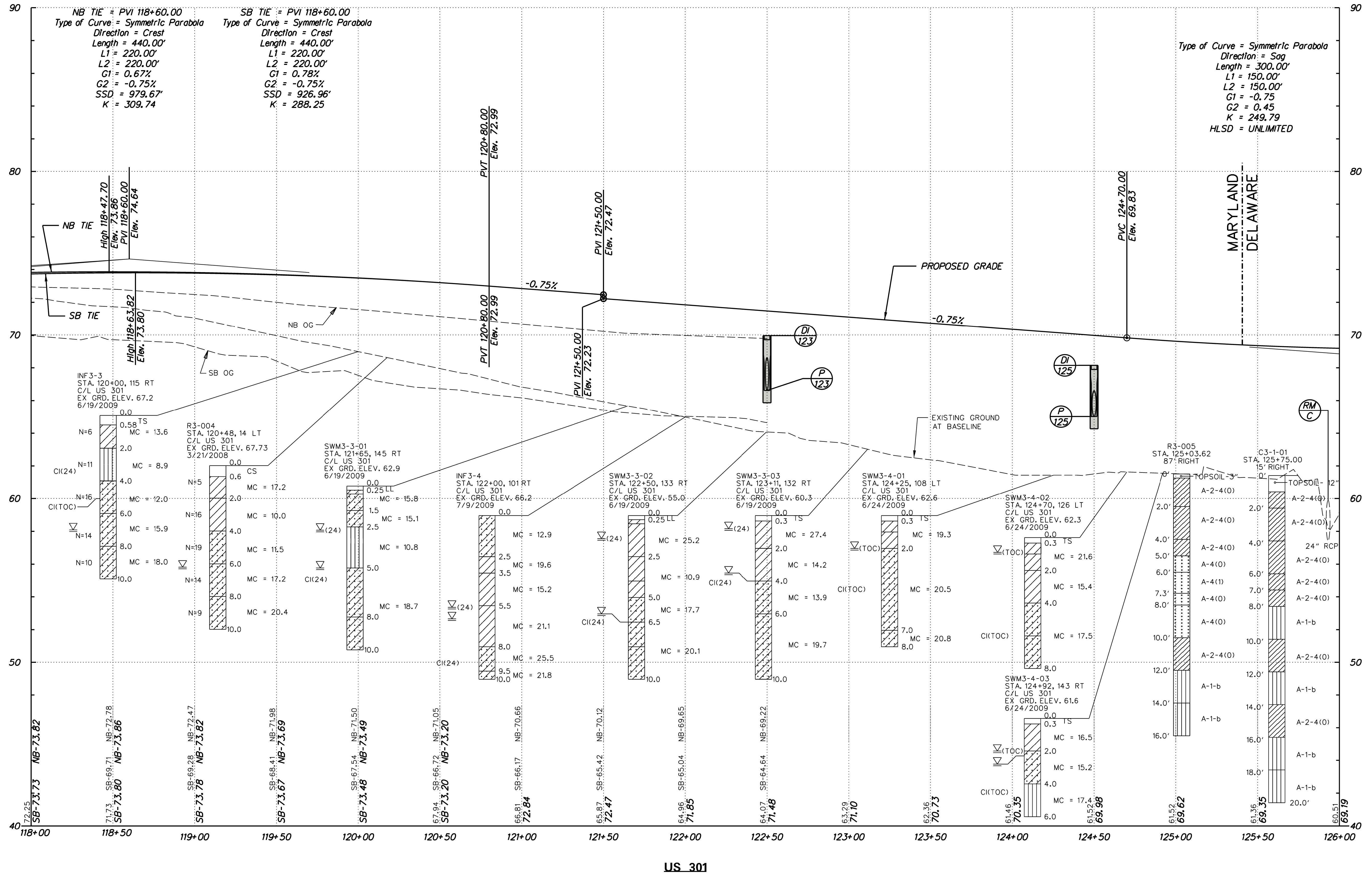

NB TIE = PVI 118+60.00
 Type of Curve = Symmetric Parabola
 Direction = Crest
 Length = 440.00'
 L1 = 220.00'
 L2 = 220.00'
 G1 = 0.67%
 G2 = -0.75%
 SSD = 979.67'
 K = 309.74

SB TIE = PVI 118+60.00
 Type of Curve = Symmetric Parabola
 Direction = Crest
 Length = 440.00'
 L1 = 220.00'
 L2 = 220.00'
 G1 = 0.78%
 G2 = -0.75%
 SSD = 926.96'
 K = 288.25

Type of Curve = Symmetric Parabola
 Direction = Sag
 Length = 300.00'
 L1 = 150.00'
 L2 = 150.00'
 G1 = -0.75%
 G2 = 0.45%
 K = 249.79
 HLSD = UNLIMITED

J:\2008 PROJECTS\34801\700CADD\750AET\ROADWAY\PF_301AET_003.DGN



ADDENDUMS / REVISIONS	

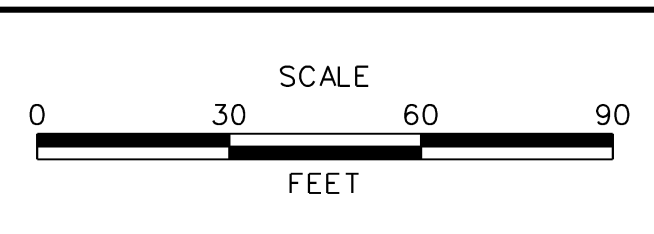

US 301
MARYLAND STATE LINE
TO LEVELS ROAD

CONTRACT T200811301	BRIDGE NO.
COUNTY CECIL	DESIGNED BY: MFM
	CHECKED BY: SKH

PROFILES	SHEET NO. 106
	TOTAL SHTS. 850

PF-03

J:\2008 PROJECTS\334801\700ADD\750AET\ROADWAY\PF_301AET_004.DGN

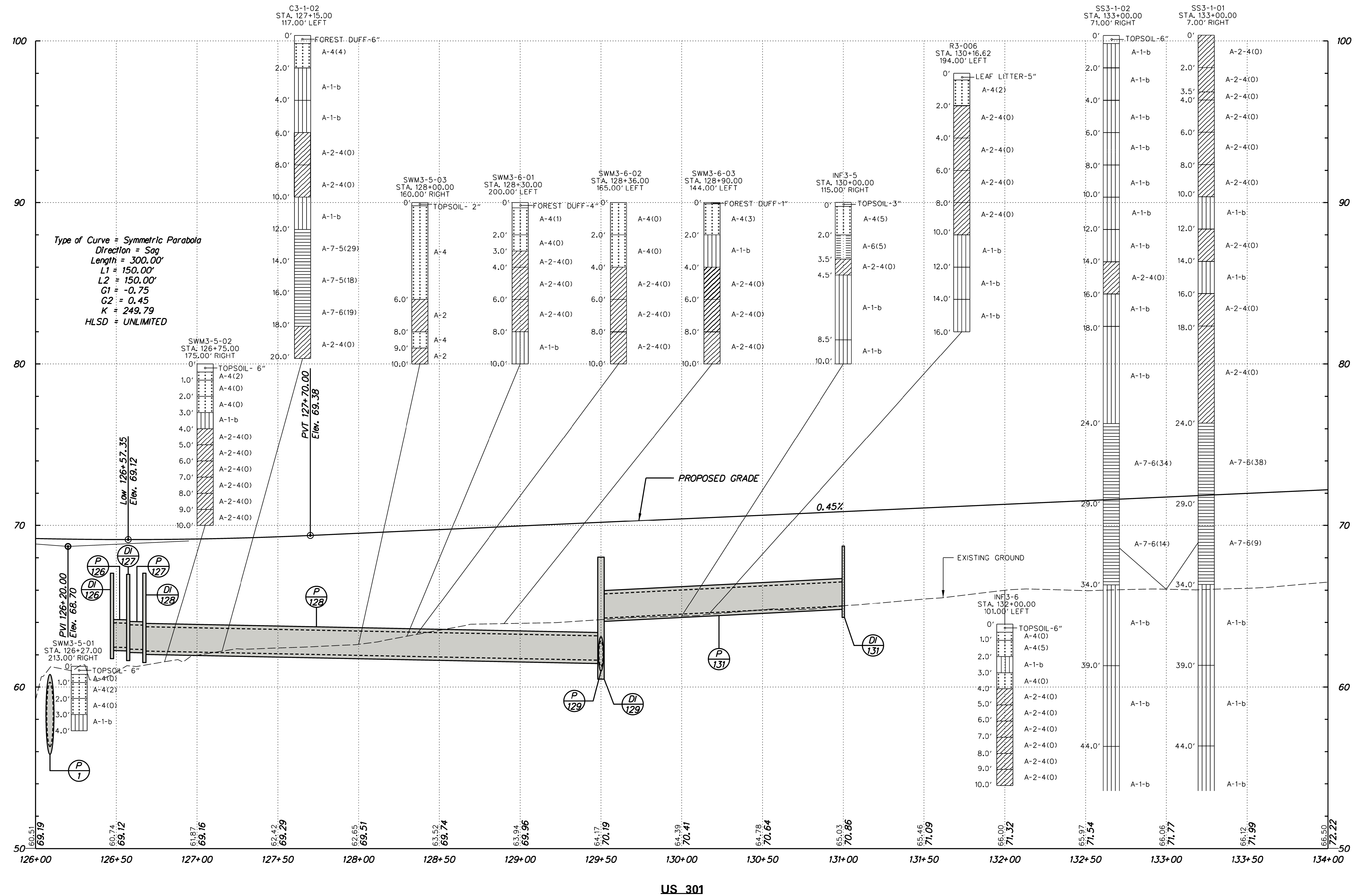

Type of Curve = Symmetric Parabola
 Direction = Sag
 Length = 300.00'
 L1 = 150.00'
 L2 = 150.00'
 G1 = -0.75
 G2 = 0.45
 K = 249.79
 HLSD = UNLIMITED

US 301

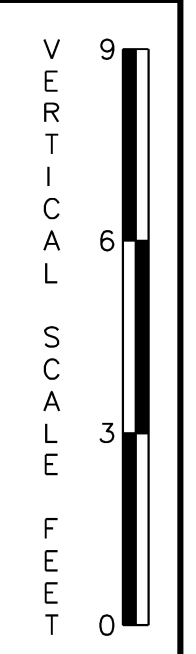

ADDENDUMS / REVISIONS	

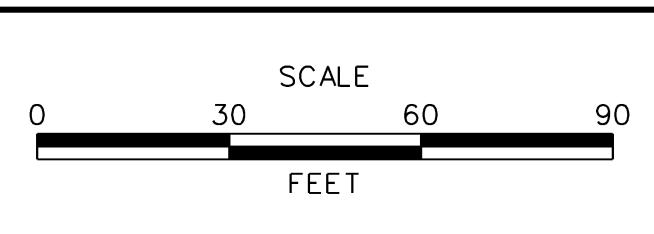

US 301
MARYLAND STATE LINE
TO LEVELS ROAD

CONTRACT T200811301	BRIDGE NO.
COUNTY NEW CASTLE	DESIGNED BY: MFM
	CHECKED BY: SKH

PROFILES	SHEET NO. 107
	TOTAL SHTS. 850

PF-04

J:\2008 PROJECTS\34801\700ROAD\ROADWAY\PF_301DS3_005.DGN

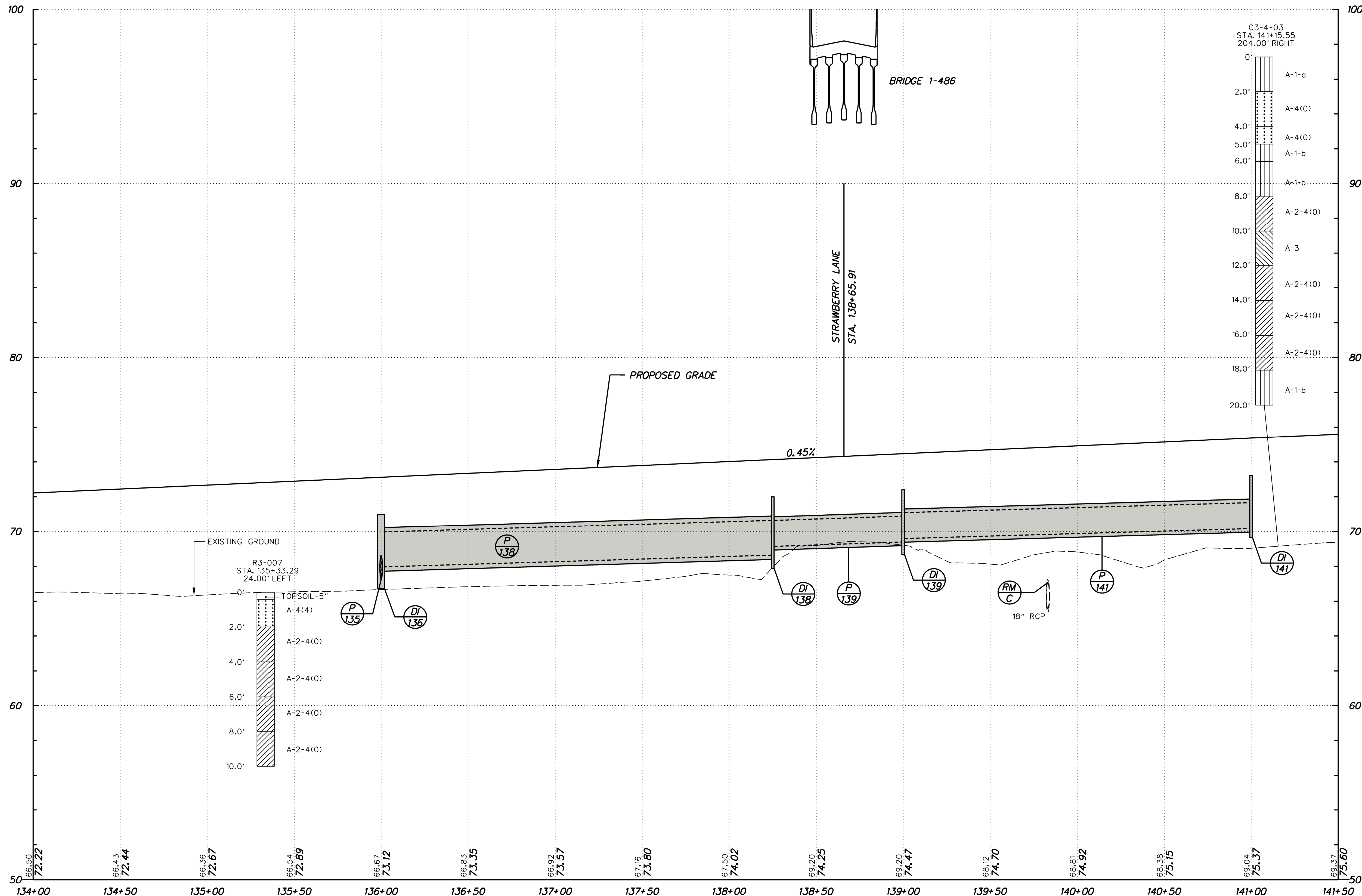

US 301



ADDENDUMS / REVISIONS	

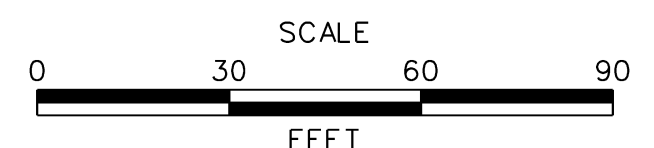

US 301
MARYLAND STATE LINE
TO LEVELS ROAD

CONTRACT	BRIDGE NO.
T200811301	
COUNTY	DESIGNED BY: MFM
NEW CASTLE	CHECKED BY: SKH

PROFILES

PF-05
SHEET NO.
108
TOTAL SHTS.
850

J:\2008 PROJECTS\334801\700ADD\750AET\ROADWAY\PF_30\AET_006.DGN

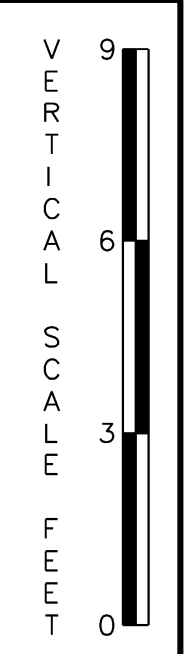
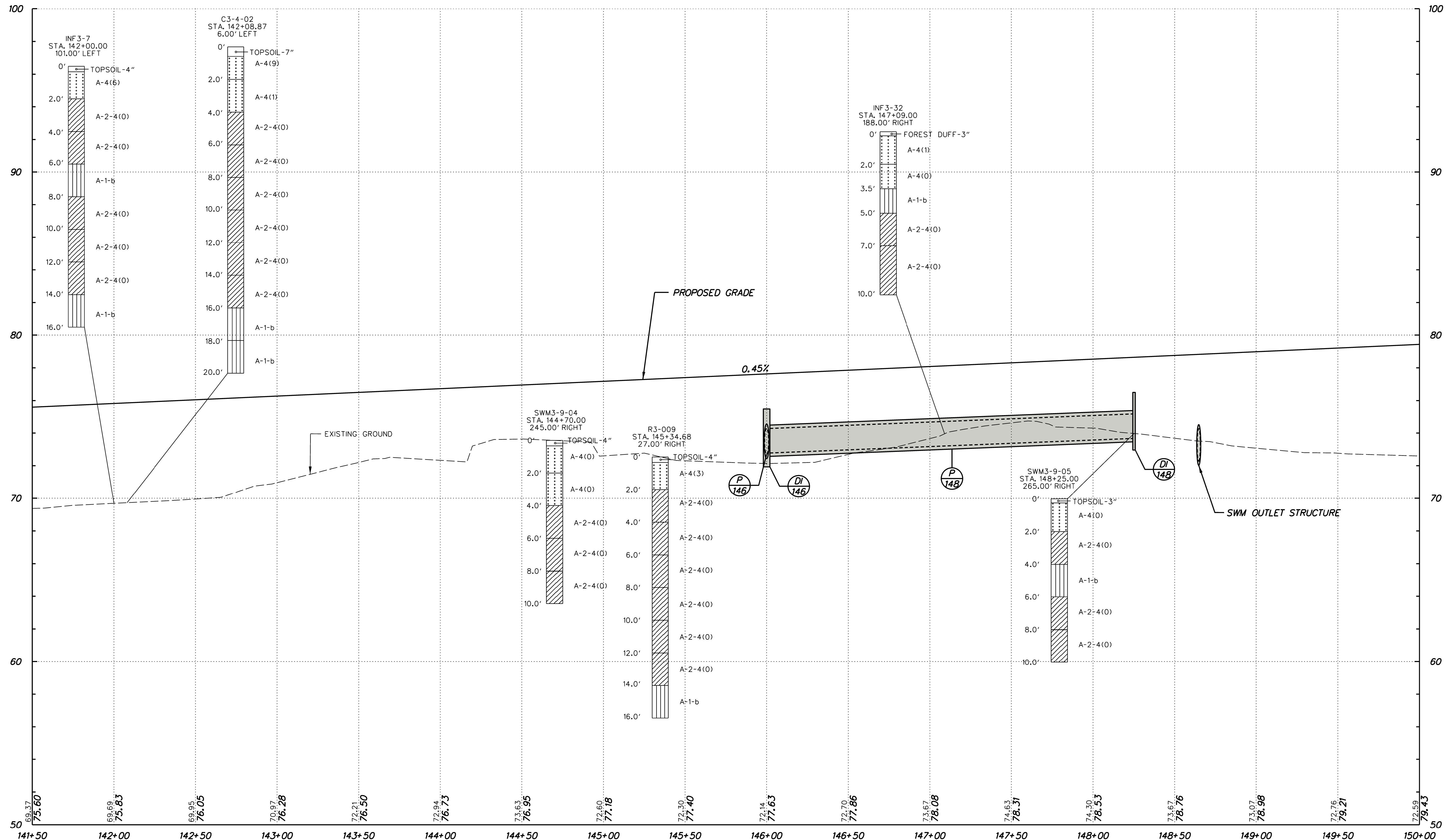

ADDENDUMS / REVISIONS	

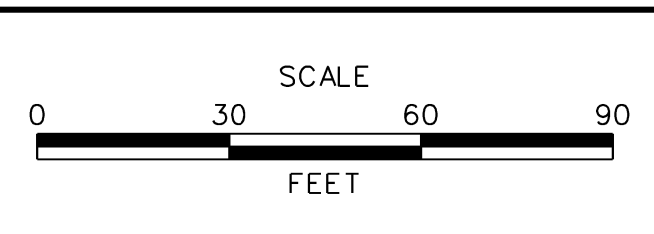

**US 301
MARYLAND STATE LINE
TO LEVELS ROAD**

CONTRACT T200811301	BRIDGE NO.
COUNTY NEW CASTLE	DESIGNED BY: MFM
	CHECKED BY: SKH

PROFILES	SHEET NO. 109
	TOTAL SHTS. 850

PF-06

J:\2008 PROJECTS\334801\700CADD\750AET\ROADWAY\PF_30\AET_007.DGN

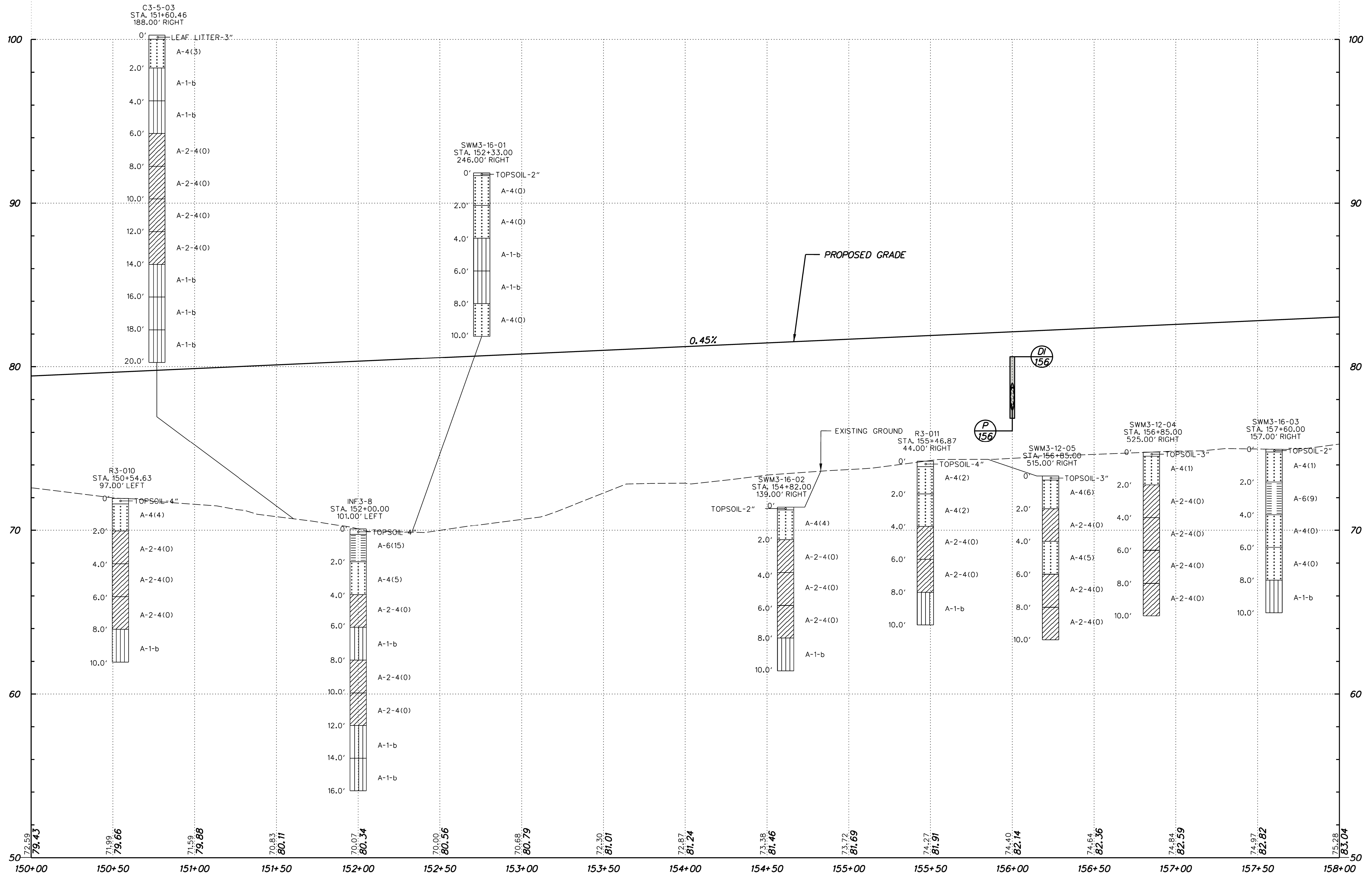

US 301

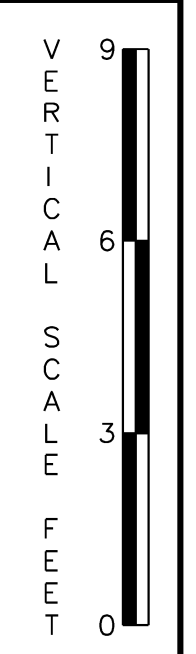

PF-07



ADDENDUMS / REVISIONS	

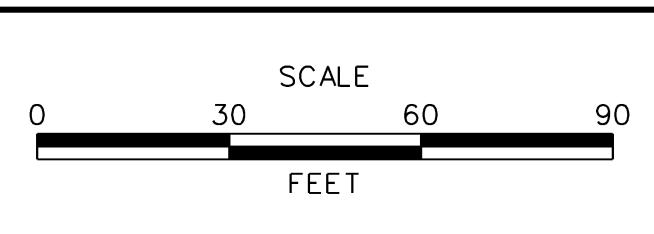

US 301
MARYLAND STATE LINE
TO LEVELS ROAD

CONTRACT	BRIDGE NO.
28-113-01	
COUNTY	DESIGNED BY: MFM
NEW CASTLE	CHECKED BY: SKH

PROFILES	SHEET NO.
	110
	TOTAL SHTS.
	850

J:\2008 PROJECTS\334801\700CADD\750AET\ROADWAY\PF_30\AET_008.DGN

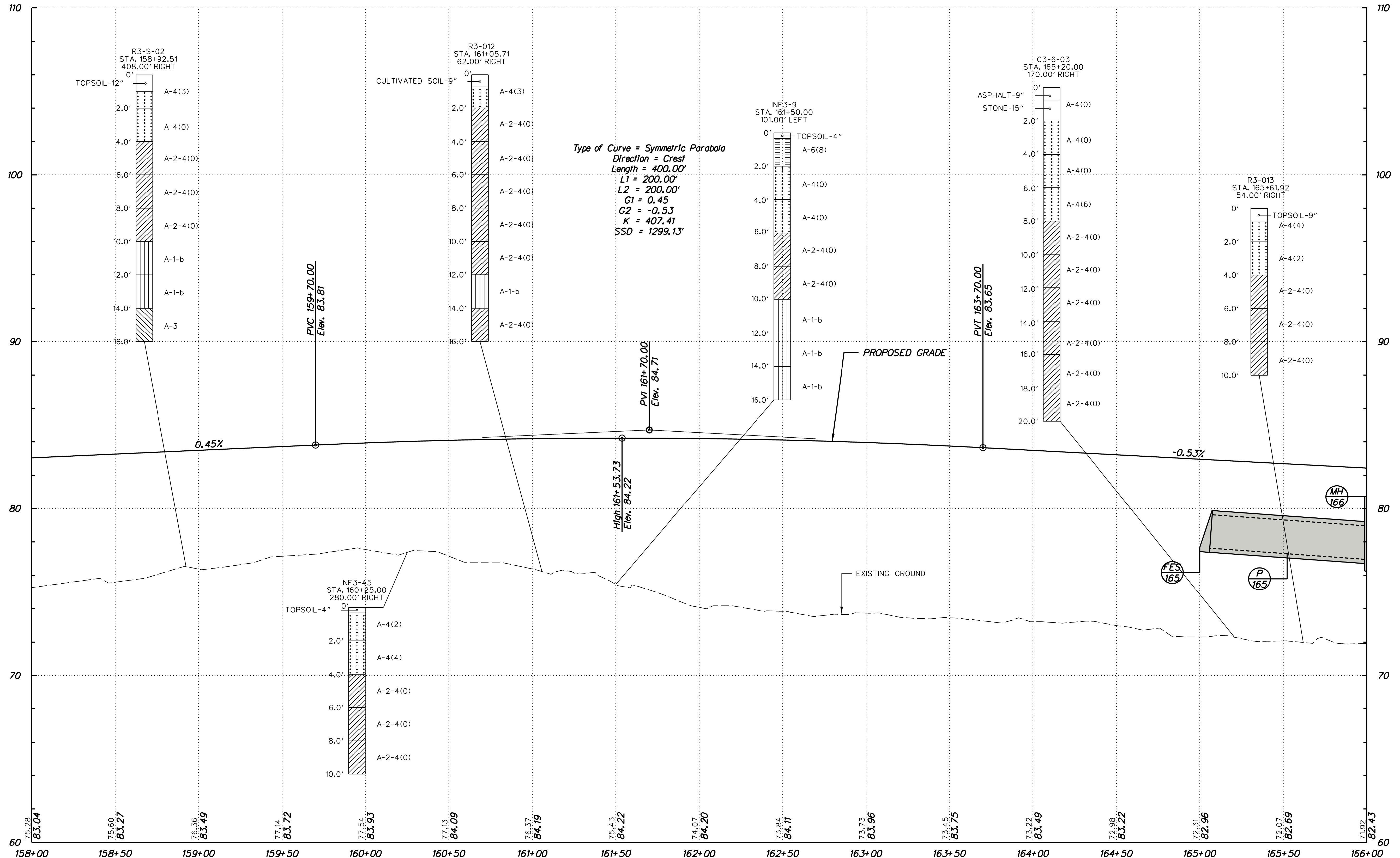

US 301

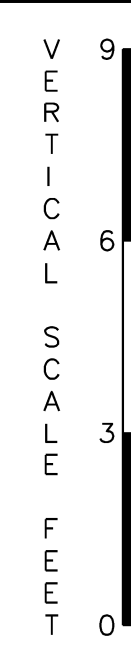

ADDENDUMS / REVISIONS	

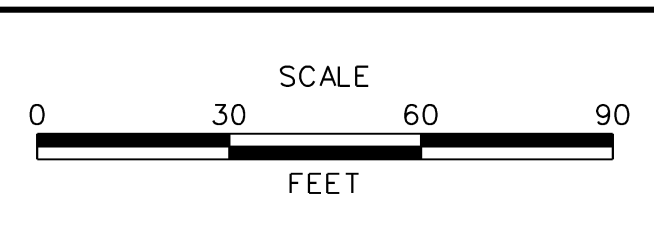

US 301
MARYLAND STATE LINE
TO LEVELS ROAD

CONTRACT	BRIDGE NO.
T200811301	
COUNTY	DESIGNED BY: MFM
NEW CASTLE	CHECKED BY: SKH

PROFILES	SHEET NO.
	111
	TOTAL SHTS.
	850

PF-08

J:\2008 PROJECTS\334801\700ADD\750AET\ROADWAY\PF_30\AET_009.DGN

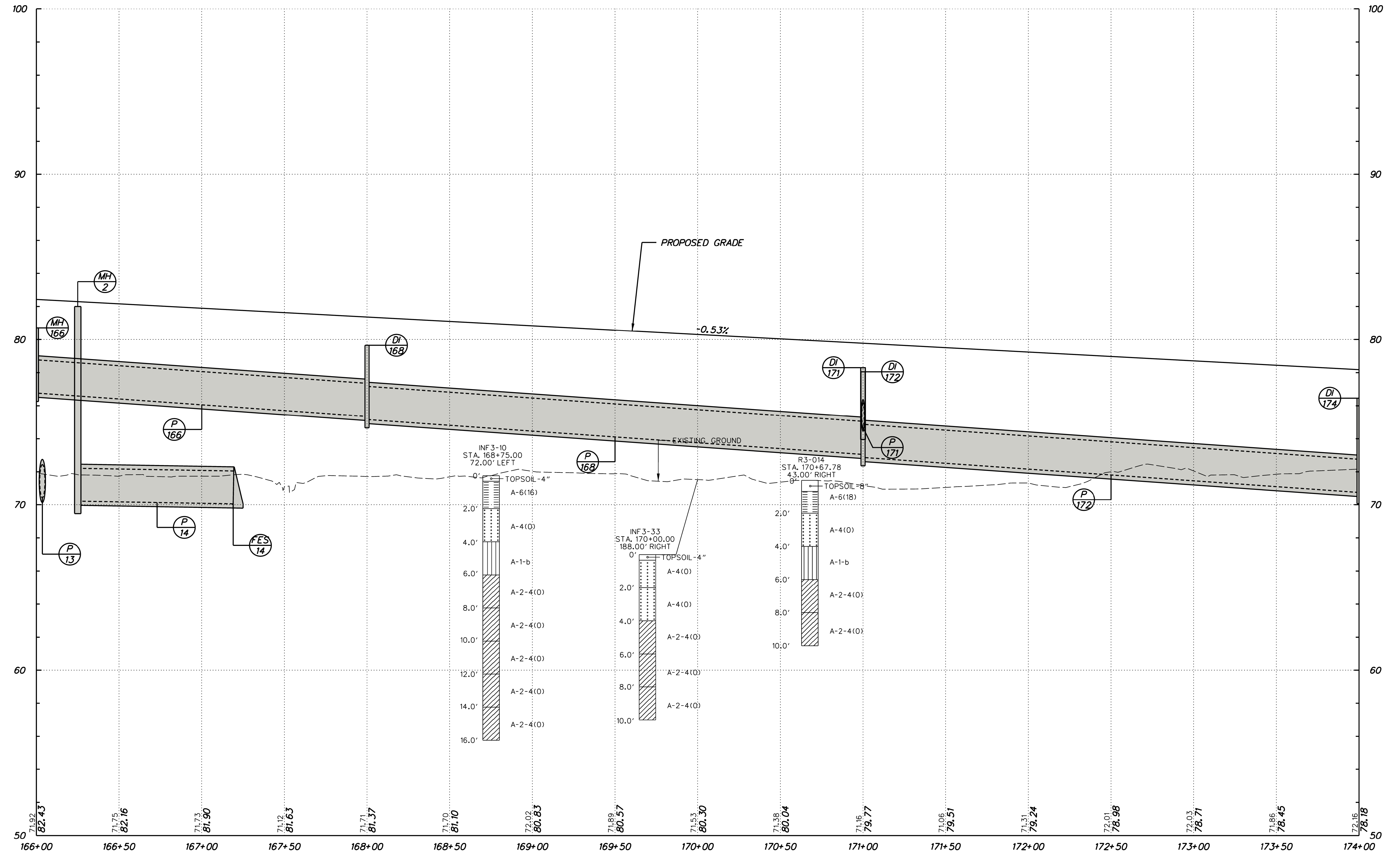

US 301

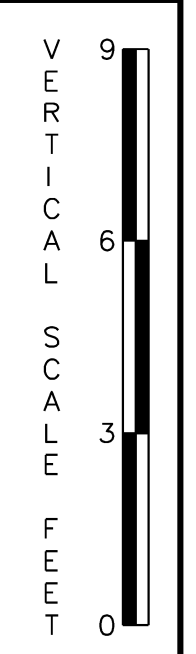

PF-09



ADDENDUMS / REVISIONS	

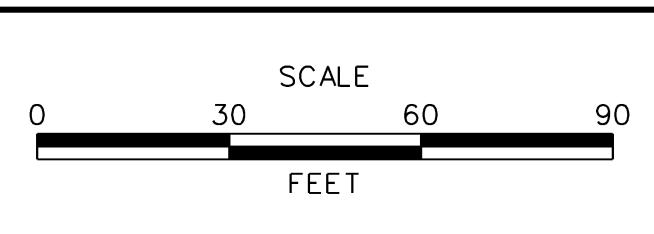

US 301
MARYLAND STATE LINE
TO LEVELS ROAD

CONTRACT	BRIDGE NO.
T200811301	
COUNTY	DESIGNED BY: MFM
NEW CASTLE	CHECKED BY: SKH

PROFILES

SHEET NO.
112
TOTAL SHTS.
850

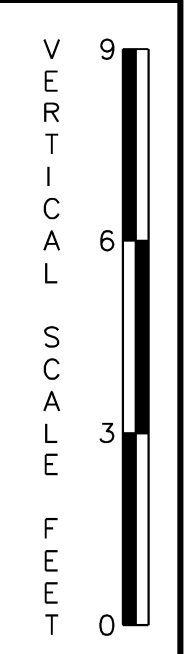
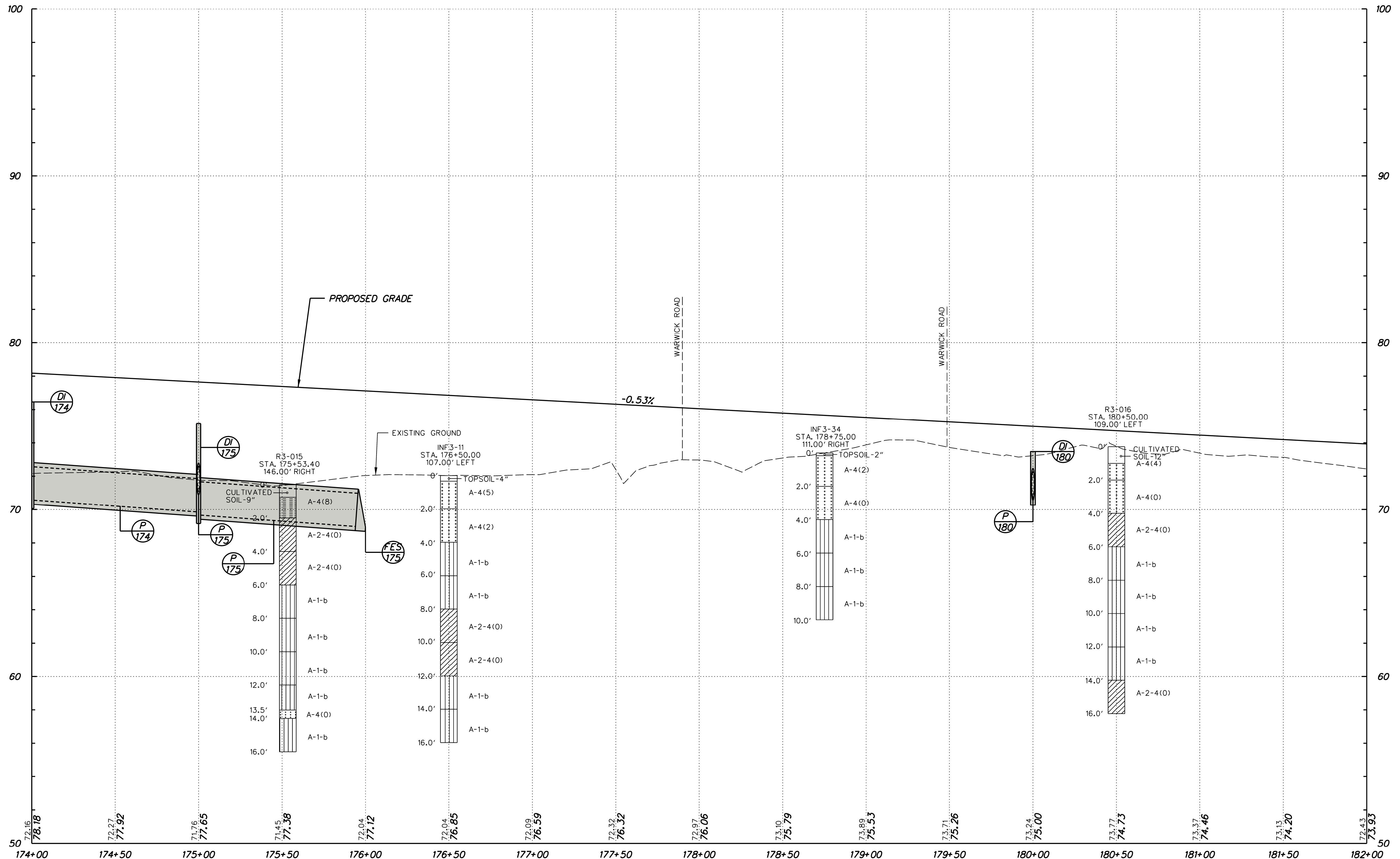

PF-10

J:\2008 PROJECTS\334801\700CADD\750AET\ROADWAY\PF_301AET_010.DGN



ADDENDUMS / REVISIONS	

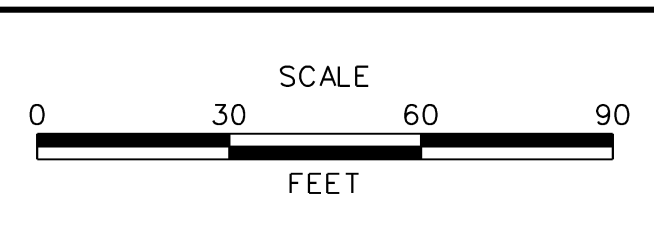

US 301
MARYLAND STATE LINE
TO LEVELS ROAD

CONTRACT	BRIDGE NO.
T200811301	
COUNTY	DESIGNED BY: MFM
NEW CASTLE	CHECKED BY: SKH

PROFILES	SHEET NO.
	113
	TOTAL SHTS.
	850

J:\2008 PROJECTS\34801\700CADD\750AET\ROADWAY\PF_30\AET_011.DGN

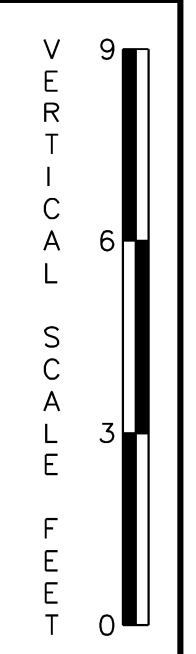
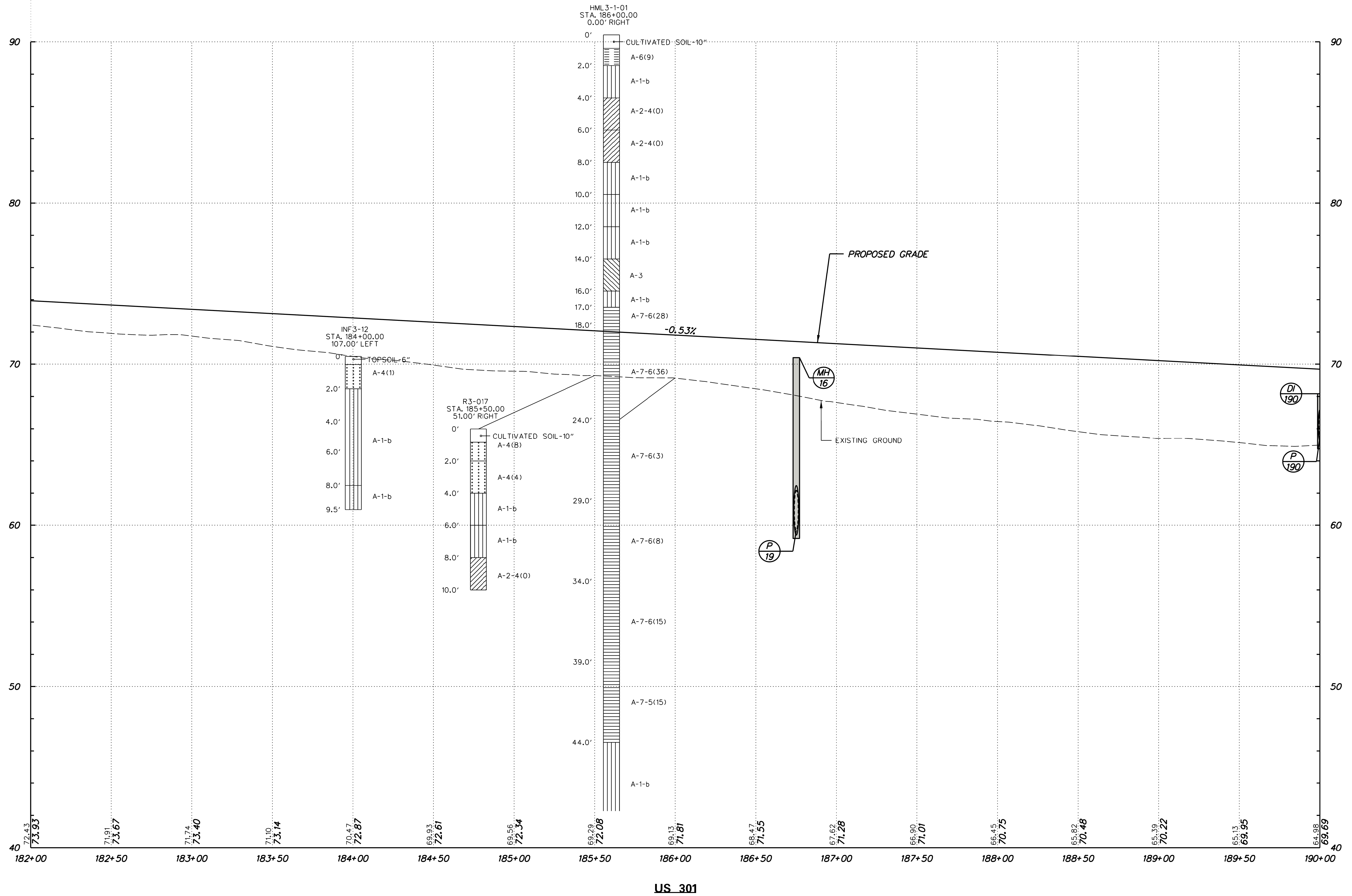

PF-11



ADDENDUMS / REVISIONS	

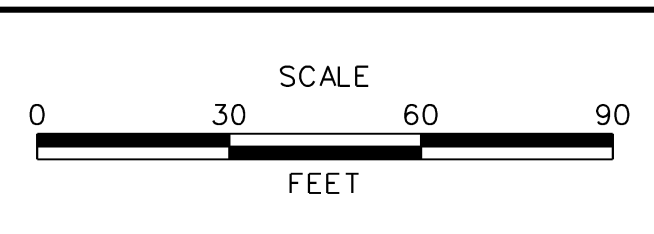

US 301
MARYLAND STATE LINE
TO LEVELS ROAD

CONTRACT	BRIDGE NO.
T200811301	
COUNTY	DESIGNED BY: MFM
NEW CASTLE	CHECKED BY: SKH

PROFILES	SHEET NO.
	114
	TOTAL SHTS.
	850

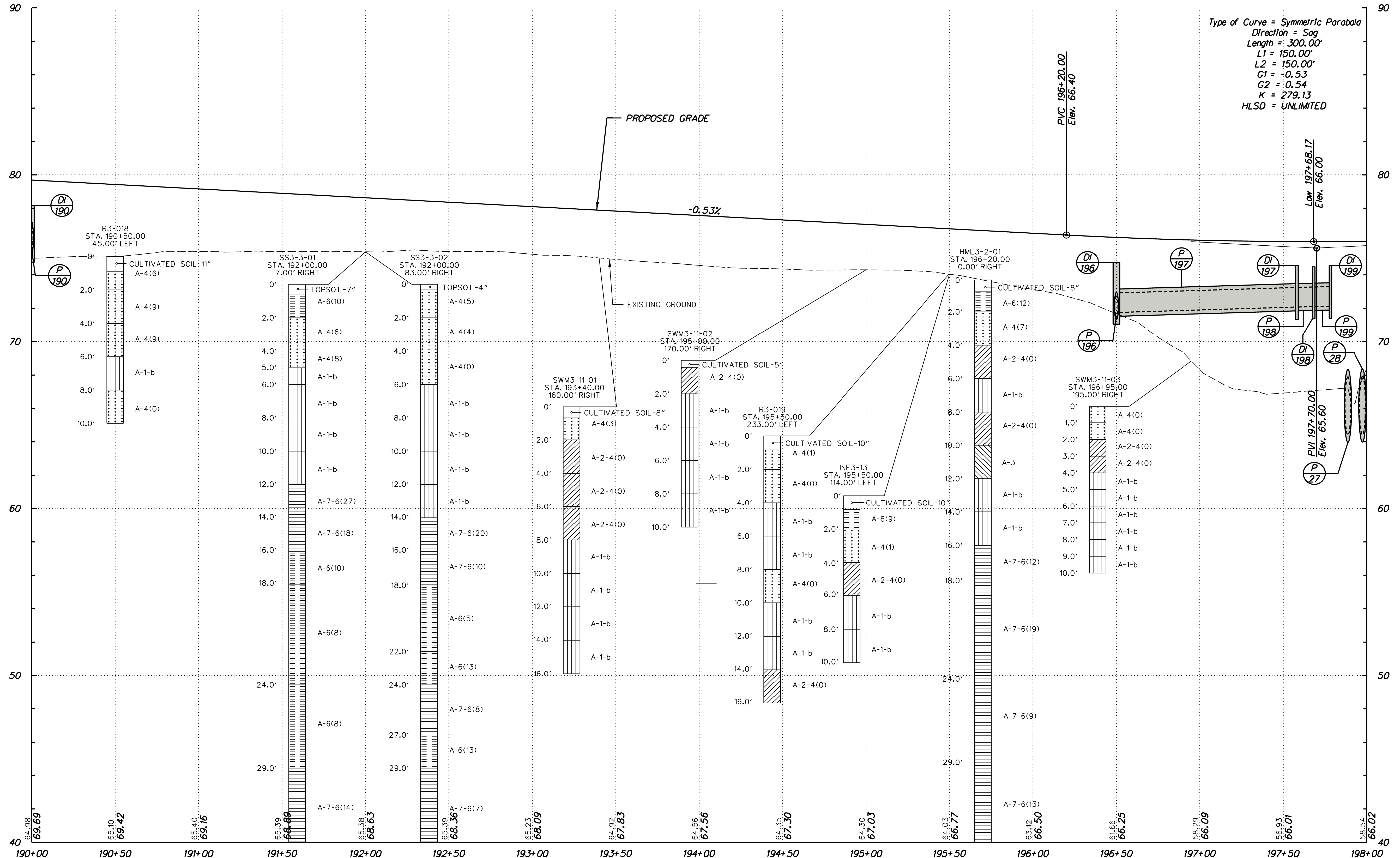

J:\2008 PROJECTS\334801\700CADD\750AET\ROADWAY\PF_301AET_012.DGN

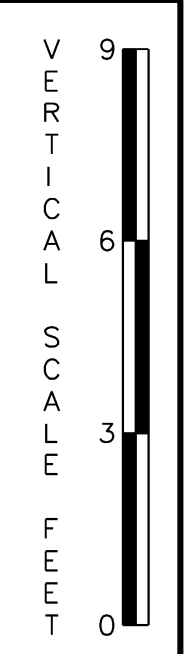

ADDENDUMS / REVISIONS	

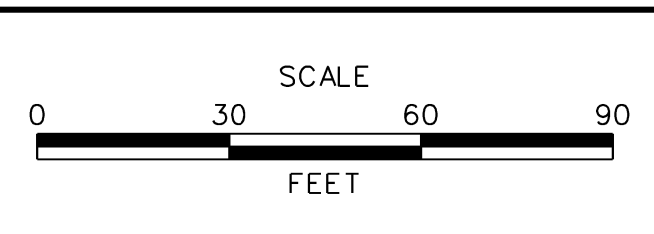

US 301
MARYLAND STATE LINE
TO LEVELS ROAD

CONTRACT	BRIDGE NO.
T200811301	
COUNTY	DESIGNED BY: MFM
NEW CASTLE	CHECKED BY: SKH

PROFILES	SHEET NO.
	115
	TOTAL SHTS.
850	

PF-12

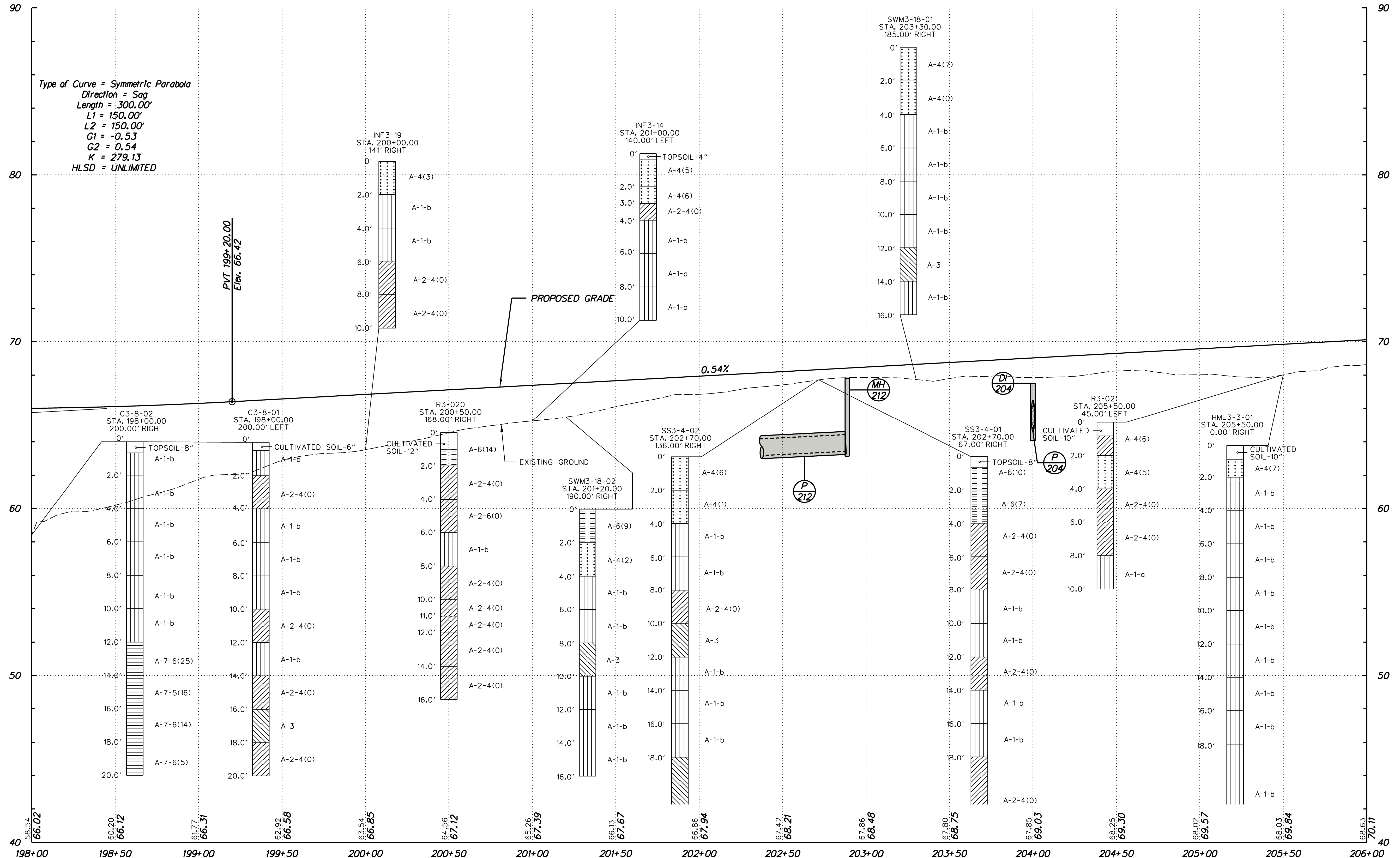

J:\2008 PROJECTS\334801\700ADD\750AET\ROADWAY\PF_301AET_013.DGN

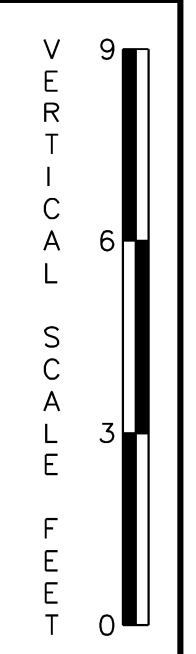

PF-13



ADDENDUMS / REVISIONS	

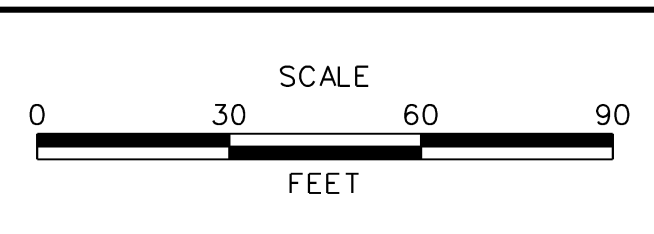

US 301
MARYLAND STATE LINE
TO LEVELS ROAD

CONTRACT	BRIDGE NO.
T200811301	
COUNTY	DESIGNED BY: MFM
NEW CASTLE	CHECKED BY: SKH

PROFILES	SHEET NO.
	116
	TOTAL SHTS.
	850

J:\2008 PROJECTS\34801\700CADD\750AET\ROADWAY\PF_301AET_014.DGN

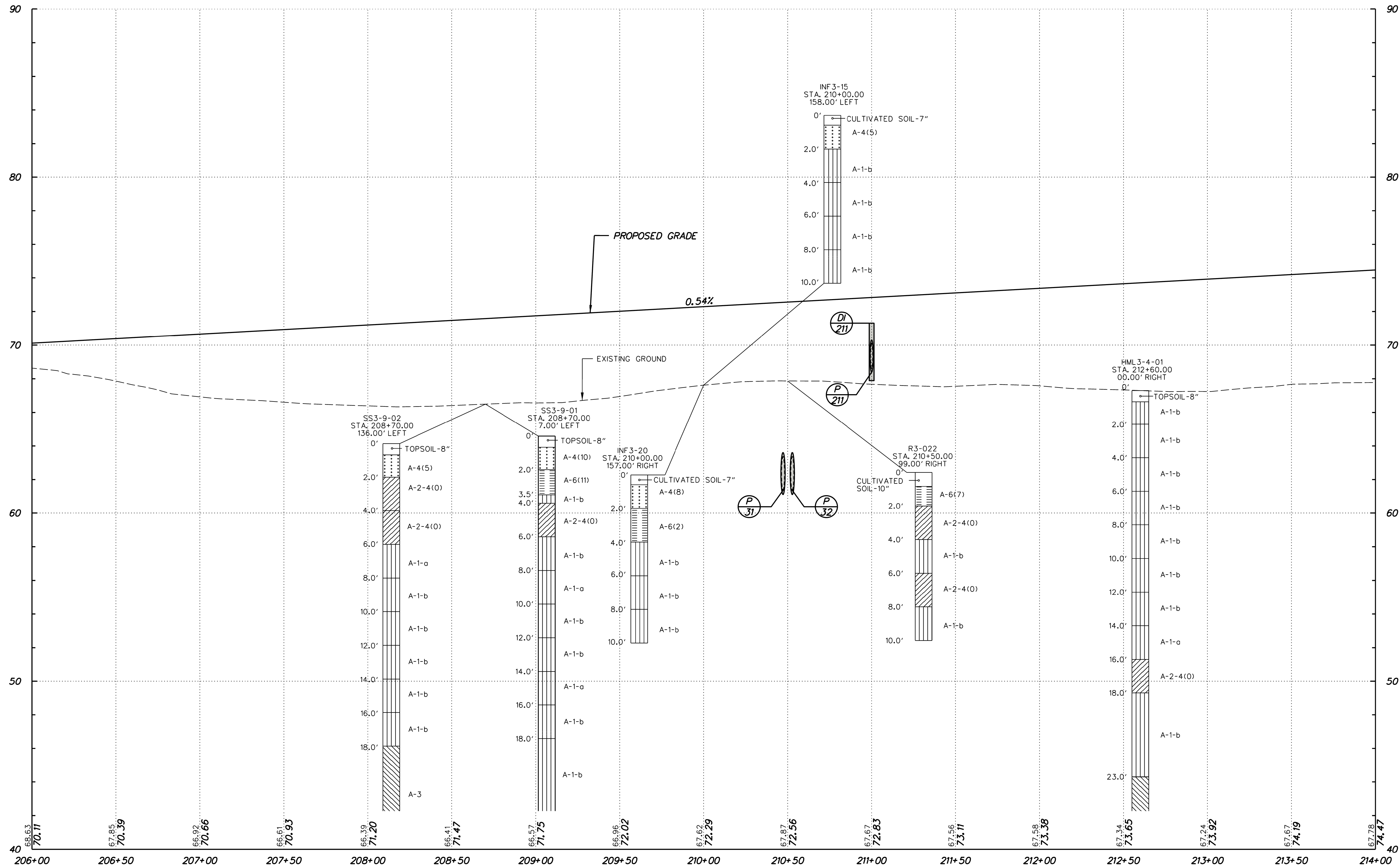

US 301

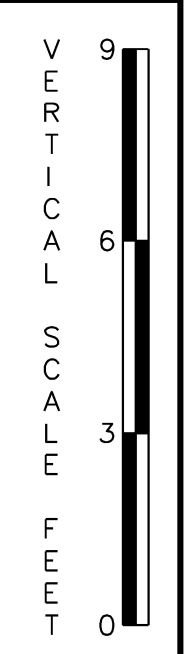

PF-14



ADDENDUMS / REVISIONS	

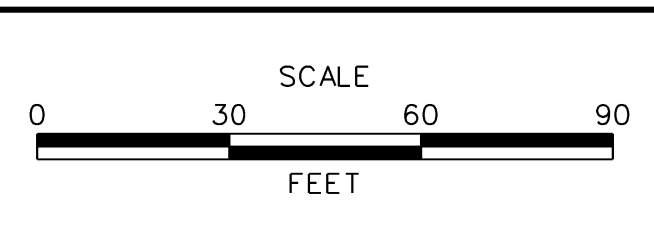

US 301
MARYLAND STATE LINE
TO LEVELS ROAD

CONTRACT	BRIDGE NO.
T200811301	
COUNTY	DESIGNED BY: MFM
NEW CASTLE	CHECKED BY: SKH

PROFILES

SHEET NO.
117
TOTAL SHTS.
850

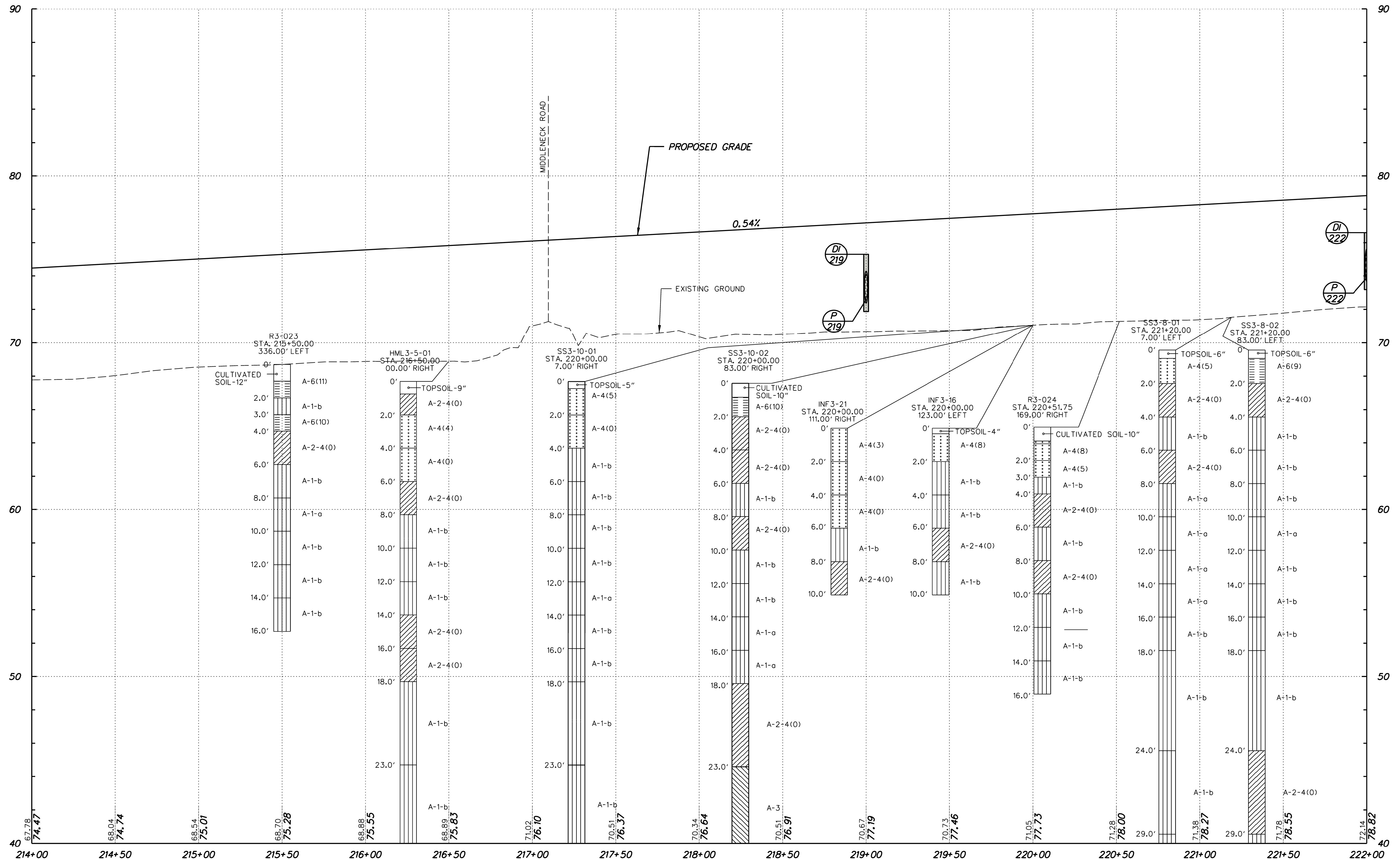

US 301

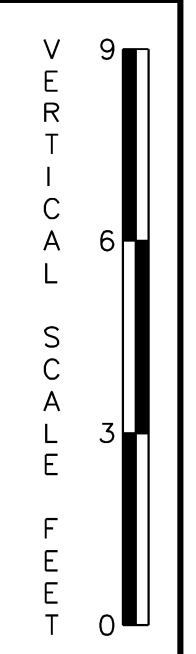

J:\2008 PROJECTS\334801\700CADD\750AET\ROADWAY\PF_301AET_015.DGN



ADDENDUMS / REVISIONS	

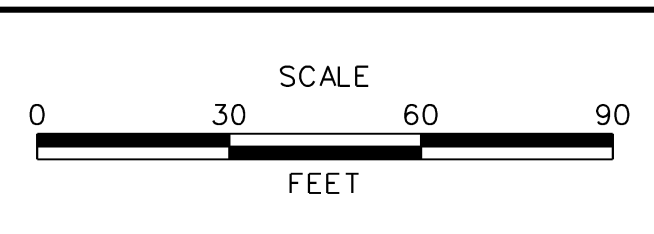

**US 301
MARYLAND STATE LINE
TO LEVELS ROAD**

CONTRACT T200811301	BRIDGE NO.
COUNTY NEW CASTLE	DESIGNED BY: MFM
	CHECKED BY: SKH

PROFILES	SHEET NO. 118
	TOTAL SHTS. 850

PF-15

J:\2008 PROJECTS\34801\700CADD\750AET\ROADWAY\PF_30\AET_016.DGN

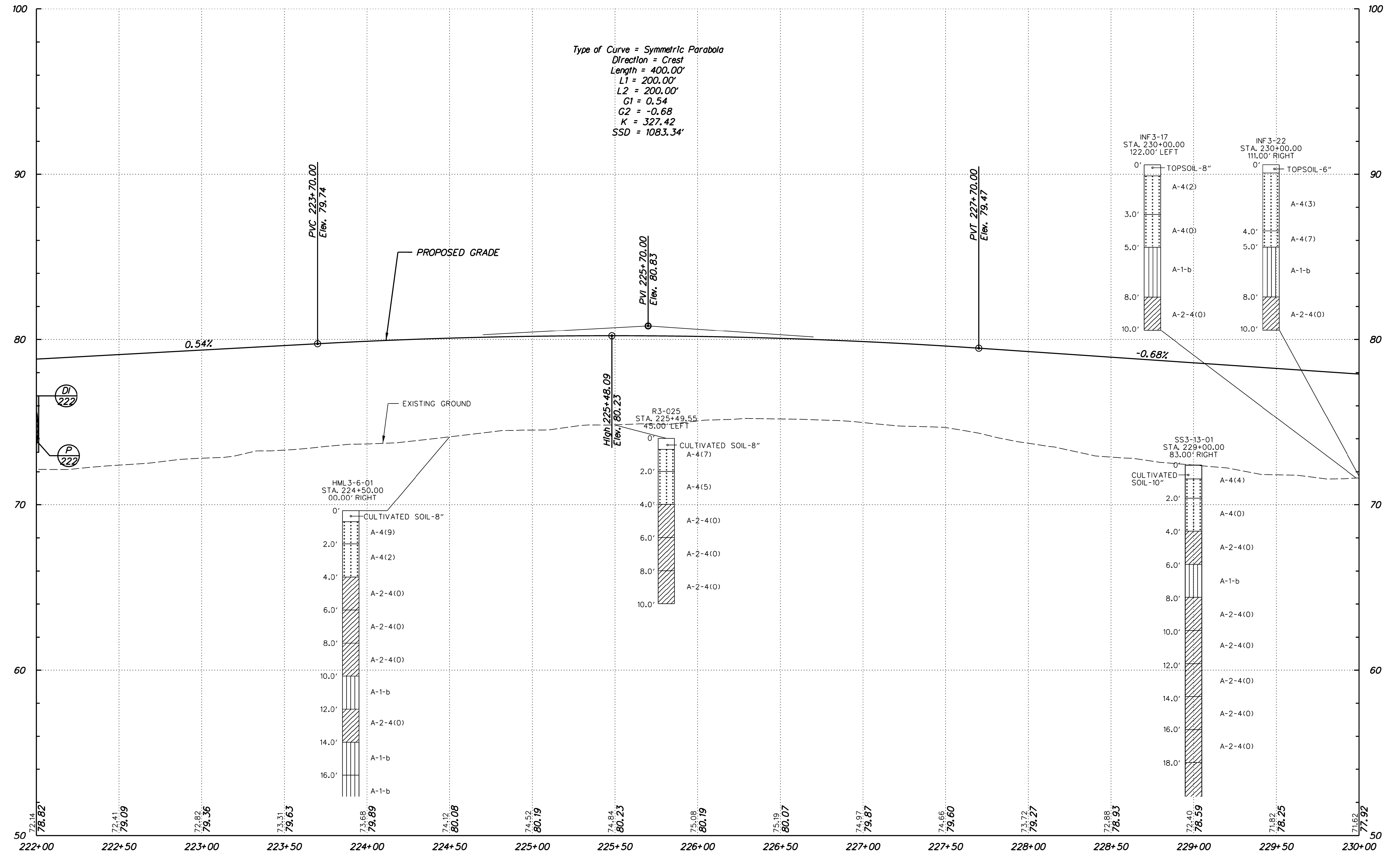

ADDENDUMS / REVISIONS	

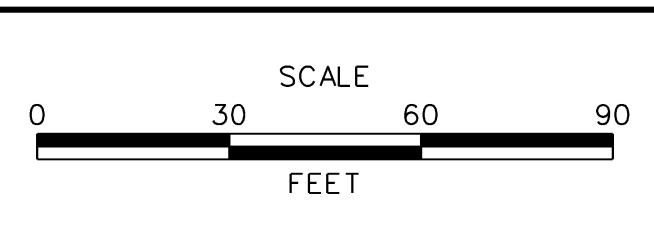

US 301
MARYLAND STATE LINE
TO LEVELS ROAD

CONTRACT	BRIDGE NO.
T200811301	DESIGNED BY: MFM
COUNTY	CHECKED BY: SKH
NEW CASTLE	

PROFILES	SHEET NO.
	119
	TOTAL SHTS.
	850

PF-16

J:\2008 PROJECTS\34801\700CADD\750AET\ROADWAY\PF_30\AET_017.DGN

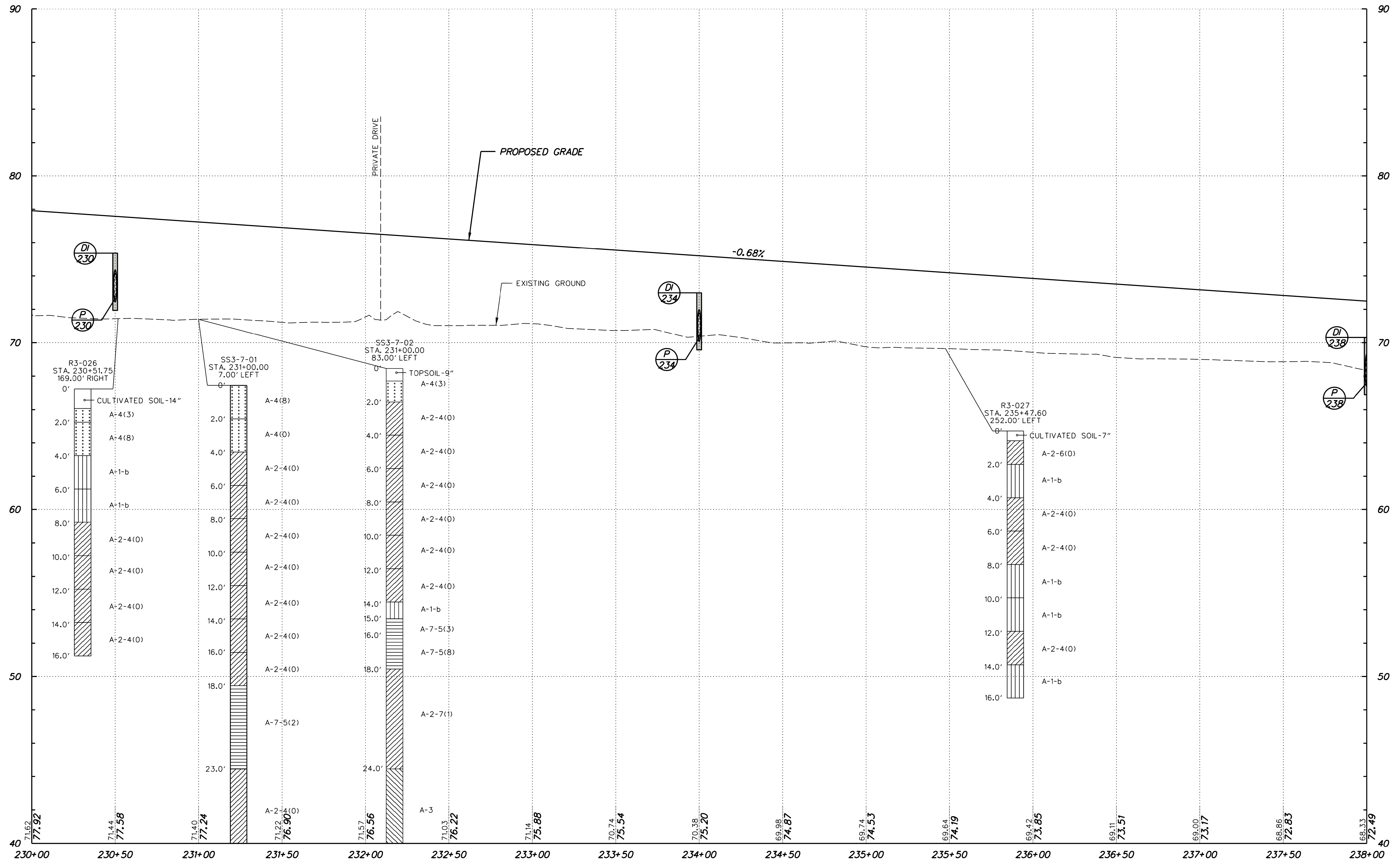

US 301

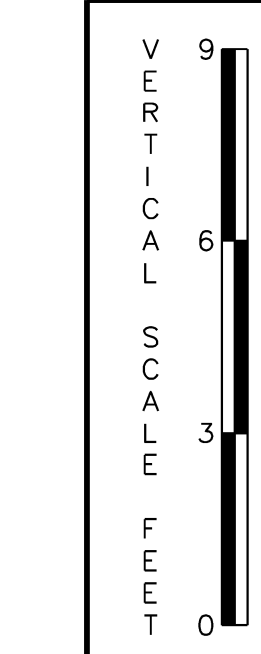

PF-17



ADDENDUMS / REVISIONS	

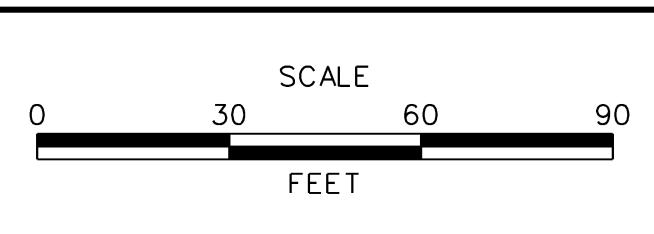

US 301
MARYLAND STATE LINE
TO LEVELS ROAD

CONTRACT	BRIDGE NO.
T200811301	
COUNTY	DESIGNED BY: MFM
NEW CASTLE	CHECKED BY: SKH

PROFILES	SHEET NO.
	120
	TOTAL SHTS.
	850

J:\2008 PROJECTS\34801\700ADD\750AET\ROADWAY\PF_30\AET_018.DGN

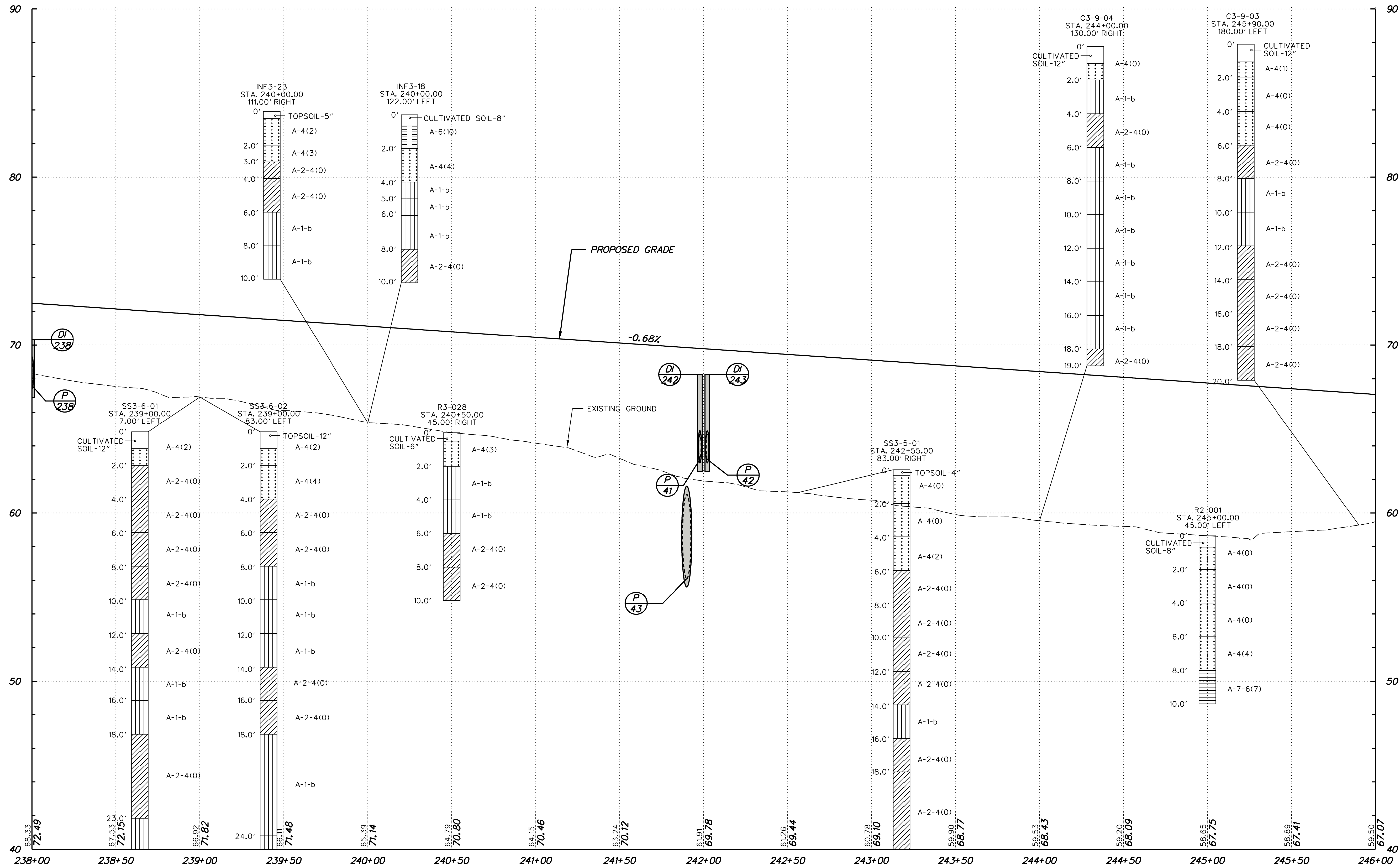

US 301

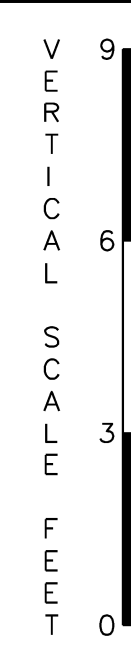

ADDENDUMS / REVISIONS	

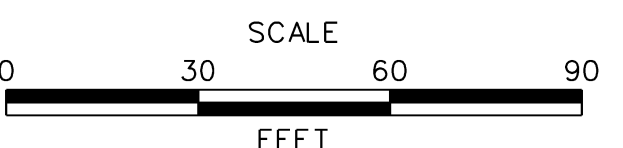

US 301
MARYLAND STATE LINE
TO LEVELS ROAD

CONTRACT T200811301	BRIDGE NO.
COUNTY NEW CASTLE	DESIGNED BY: MFM
	CHECKED BY: SKH

PROFILES

PF-18	SHEET NO. 121
	TOTAL SHTS. 850

J:\2008 PROJECTS\34801\700CADD\750AET\ROADWAY\PF_30\AET_019.DGN

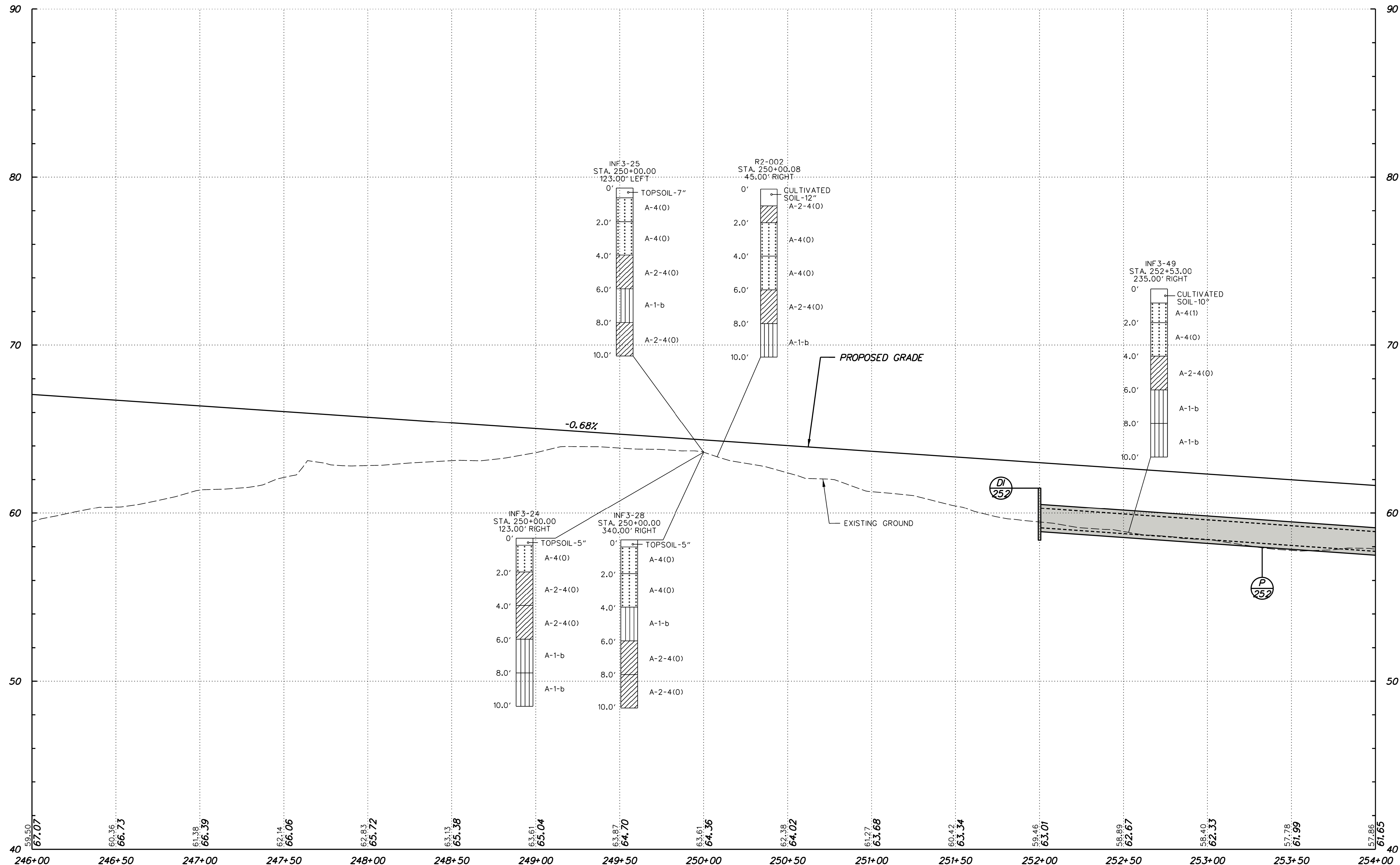

US 301

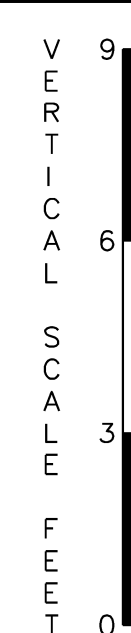

PF-19



ADDENDUMS / REVISIONS	

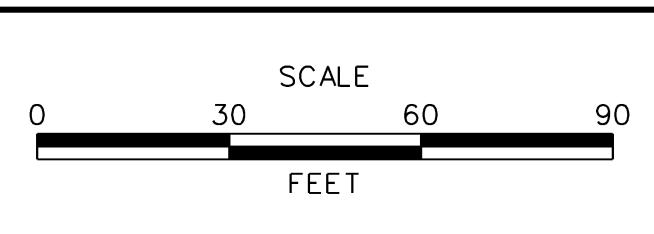

US 301
MARYLAND STATE LINE
TO LEVELS ROAD

CONTRACT	BRIDGE NO.
T200811301	
COUNTY	DESIGNED BY: MFM
NEW CASTLE	CHECKED BY: SKH

PROFILES

SHEET NO.
122
TOTAL SHTS.
850

J:\2008 PROJECTS\34801\700ADD\750AET\ROADWAY\PF_30\AET_020.DGN

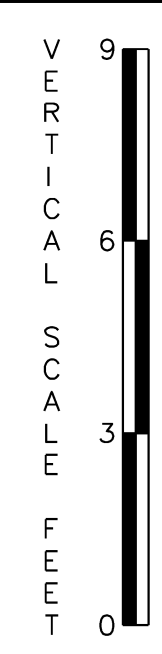
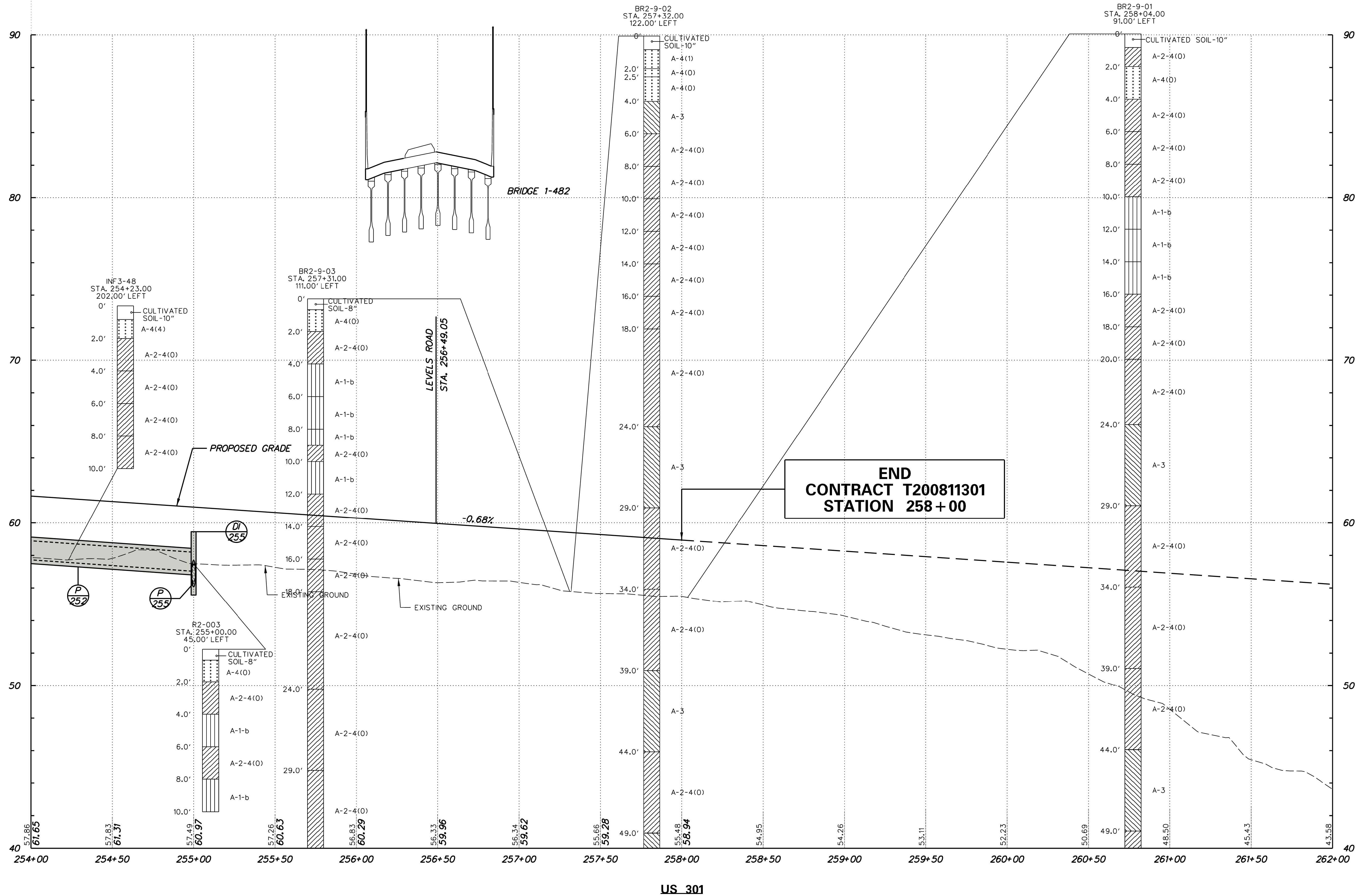

PF-20



ADDENDUMS / REVISIONS	

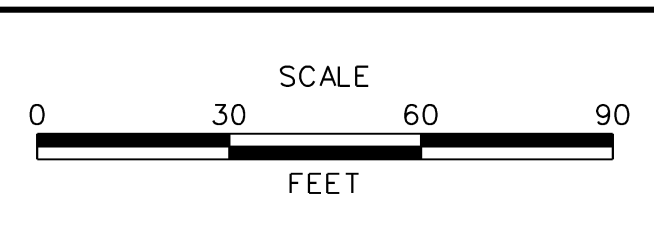

US 301
MARYLAND STATE LINE
TO LEVELS ROAD

CONTRACT	BRIDGE NO.
T200811301	123
COUNTY	DESIGNED BY: MFM
NEW CASTLE	CHECKED BY: SKH

PROFILES	SHEET NO.
	123
	TOTAL SHTS.
	850

J:\2008 PROJECTS\E3\34801\700CADD\750AET\ROADWAY\PF_301AET_021.DGN

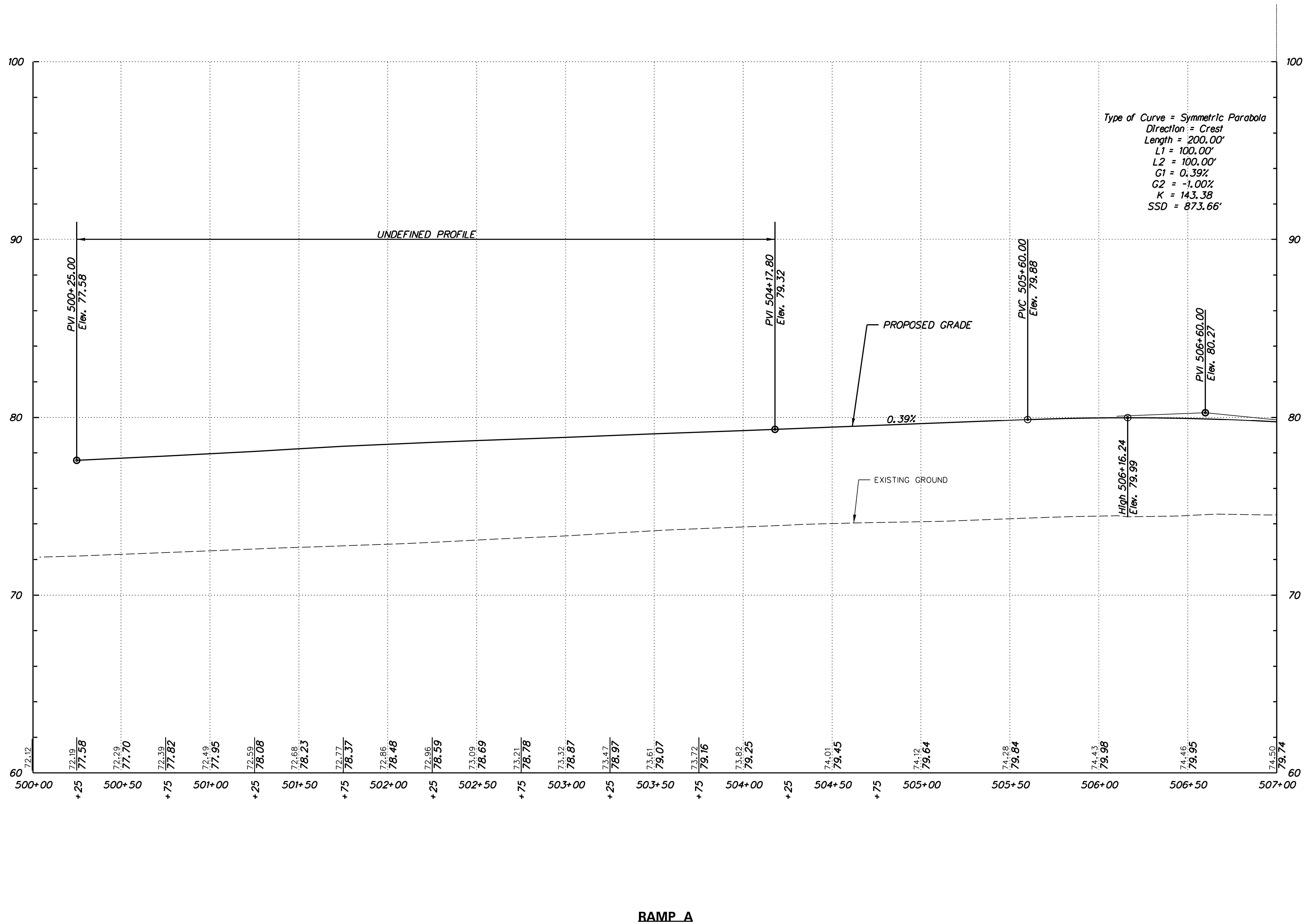

RAMP A



ADDENDUMS / REVISIONS	

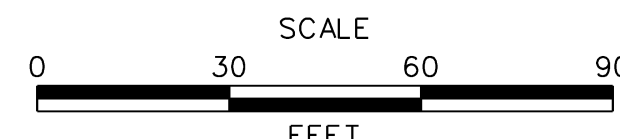

**US 301
MARYLAND STATE LINE
TO LEVELS ROAD**

CONTRACT	BRIDGE NO.
T200811301	
COUNTY	DESIGNED BY: MFM
NEW CASTLE	CHECKED BY: SKH

PROFILES

PF-21
SHEET NO. 124
TOTAL SHTS. 850

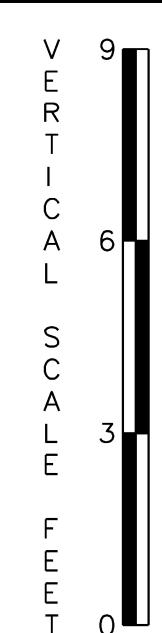

J:\2008 PROJECTS\3X34801\700CADD\750AET\ROADWAY\PF_301AET_022.DGN

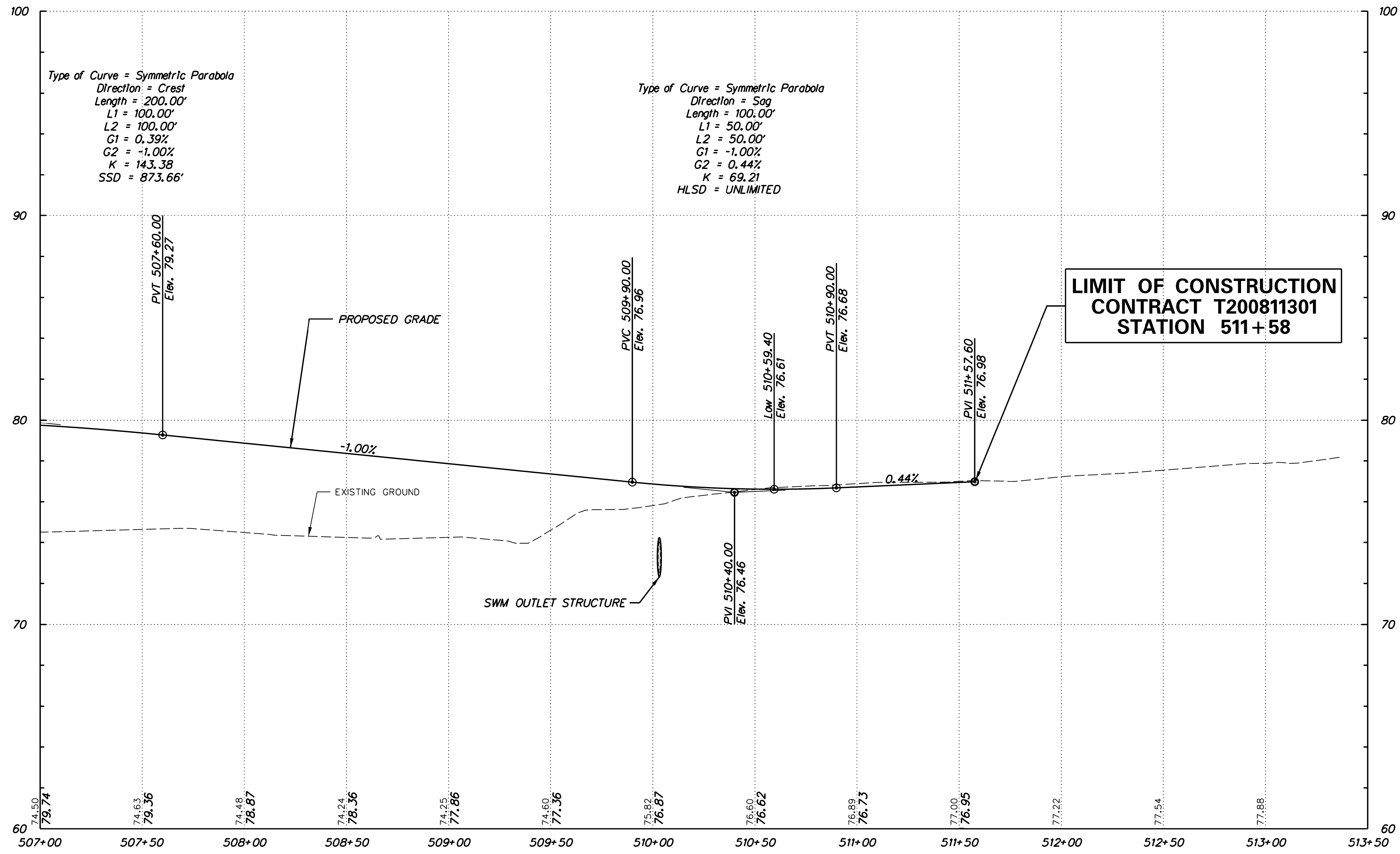

RAMP_A

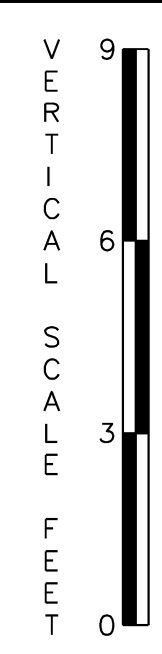

PF-22



ADDENDUMS / REVISIONS	

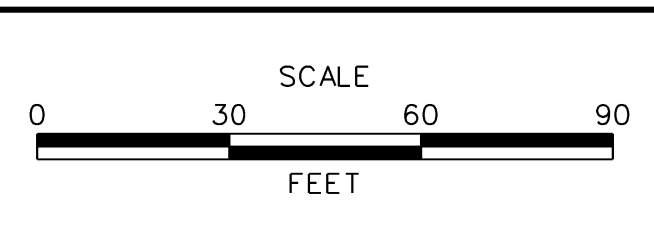

US 301
MARYLAND STATE LINE
TO LEVELS ROAD

CONTRACT	BRIDGE NO.
T200811301	
COUNTY	DESIGNED BY: MFM
NEW CASTLE	CHECKED BY: SKH

PROFILES

SHEET NO.
125
TOTAL SHTS.
850

J:\2008 PROJECTS\3X34801\700CADD\750AET\ROADWAY\PF_301AET_023.DGN

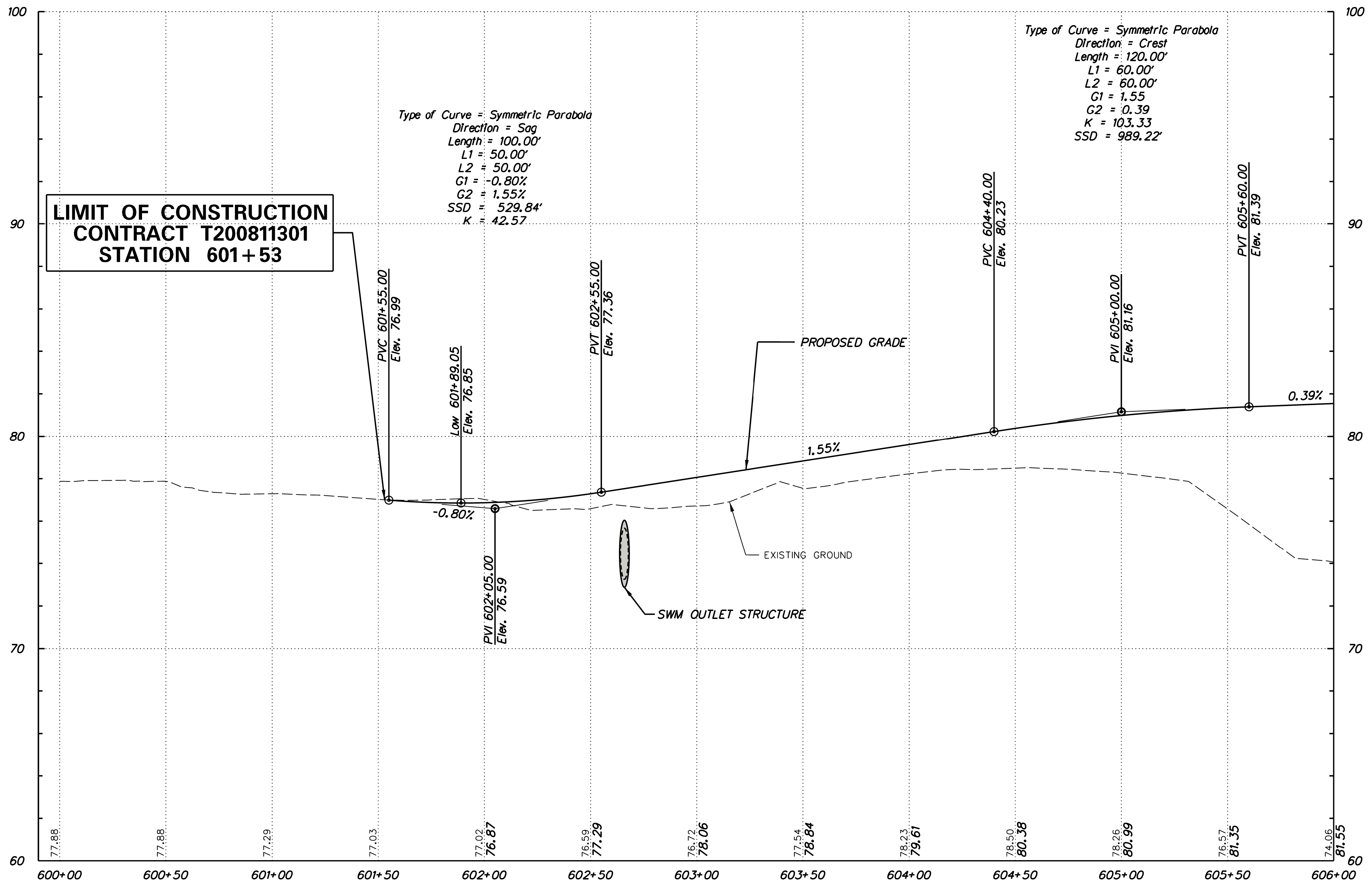

RAMP B

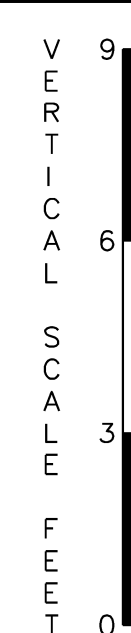

PF-23



ADDENDUMS / REVISIONS	

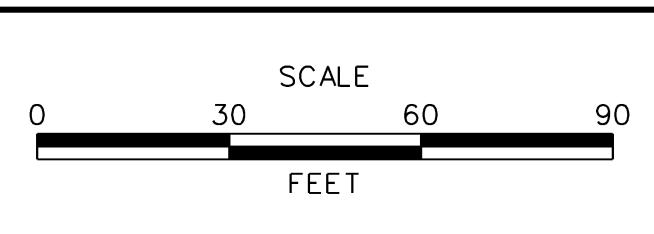

US 301
MARYLAND STATE LINE
TO LEVELS ROAD

CONTRACT	BRIDGE NO.
T200811301	
COUNTY	DESIGNED BY: MFM
NEW CASTLE	CHECKED BY: SKH

PROFILES	SHEET NO.
	126
	TOTAL SHTS.
	850

J:\2008 PROJECTS\3X34801\700CADD\750AET\ROADWAY\PF_301AET_024.DGN

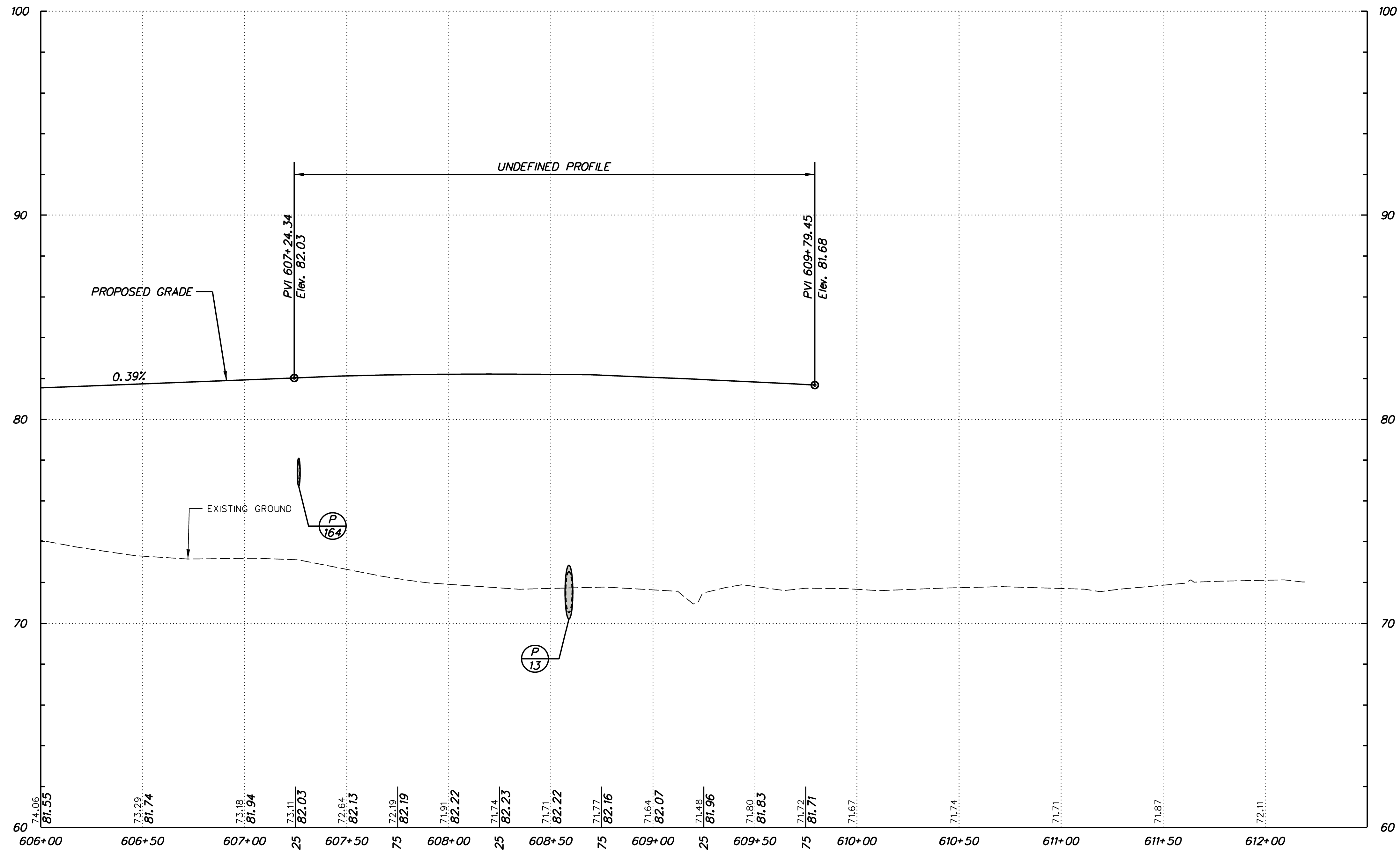

RAMP B

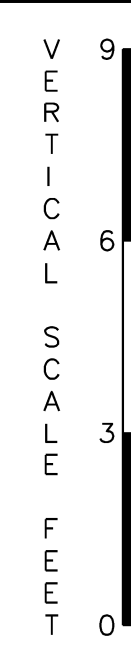

PF-24



ADDENDUMS / REVISIONS	

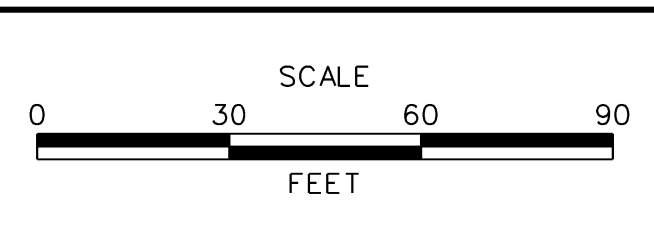

US 301 MARYLAND STATE LINE TO LEVELS ROAD

CONTRACT	BRIDGE NO.
T200811301	
COUNTY	DESIGNED BY: MFM
NEW CASTLE	CHECKED BY: SKH

PROFILES

SHEET NO.
127
TOTAL SHTS.
850

J:\2008 PROJECTS\3X34801\700CADD\750AET\ROADWAY\PF_301AET_025.DGN

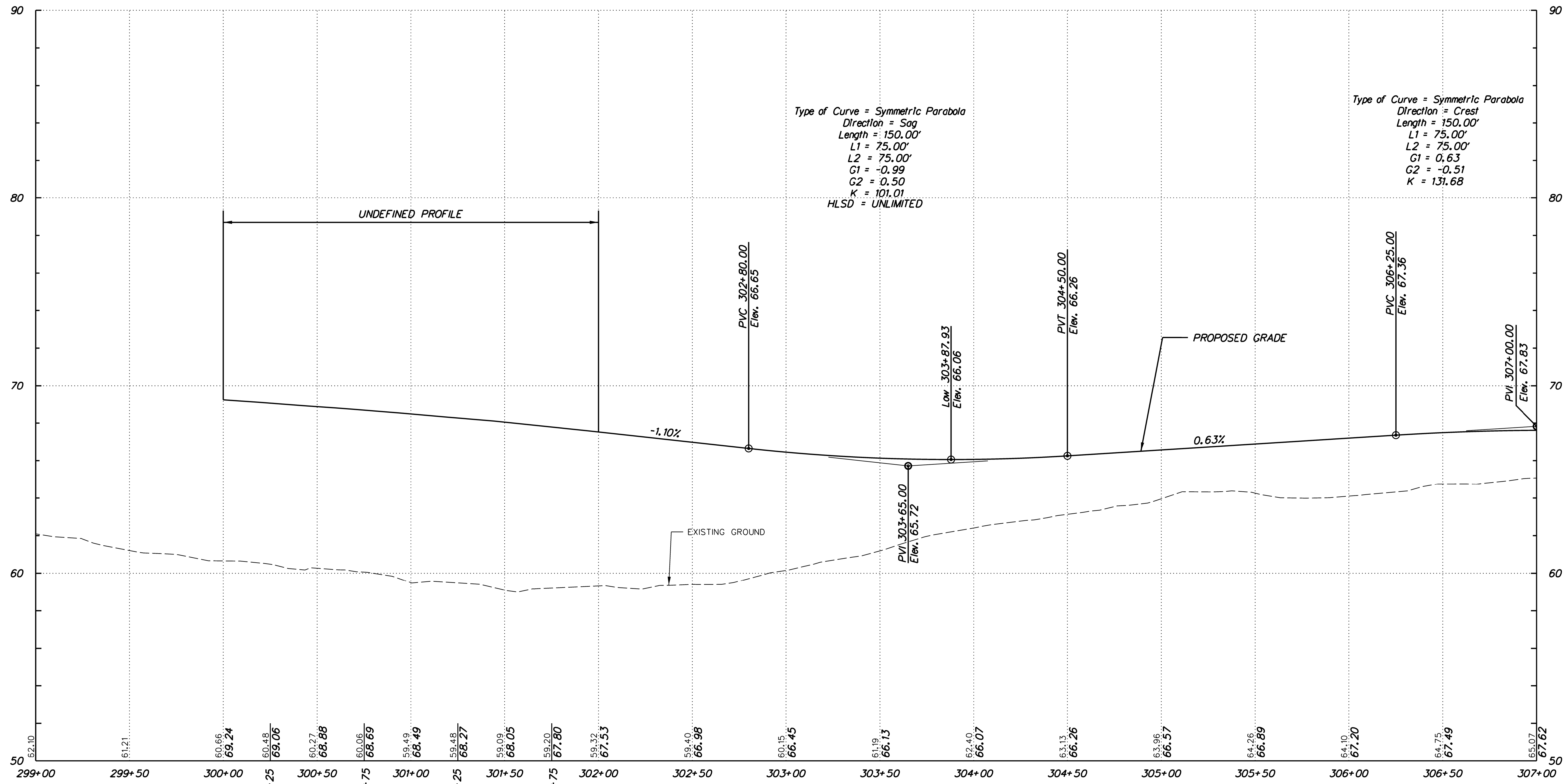

RAMP_D

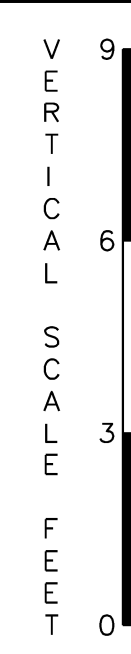

PF-25



ADDENDUMS / REVISIONS	

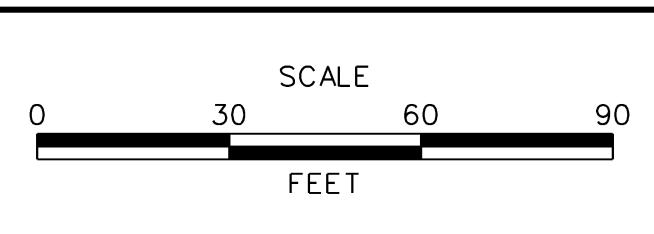

US 301
MARYLAND STATE LINE
TO LEVELS ROAD

CONTRACT	BRIDGE NO.
T200811301	
COUNTY	DESIGNED BY: MFM
NEW CASTLE	CHECKED BY: SKH

PROFILES	SHEET NO.
	128
	TOTAL SHTS.
	850

J:\2008 PROJECTS\3X34801\700CADD\750AET\ROADWAY\PF_301AET_026.DGN

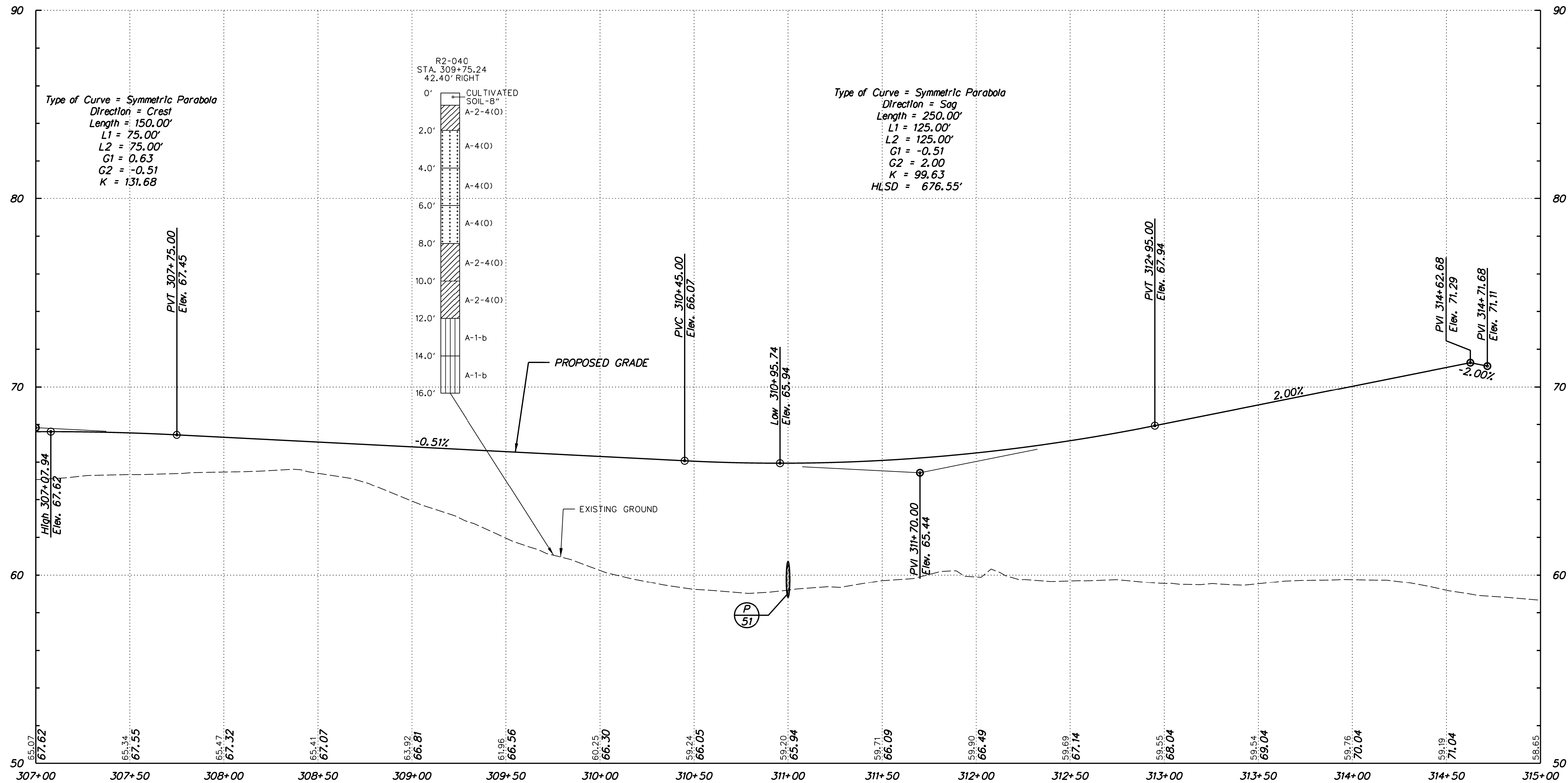

P
51

RAMP_D

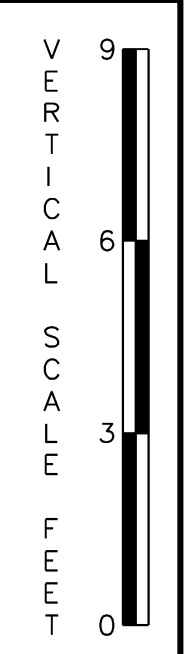

PF-26



ADDENDUMS / REVISIONS	

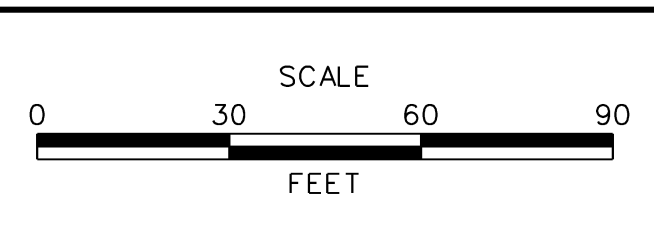

US 301
 MARYLAND STATE LINE
 TO LEVELS ROAD

CONTRACT	BRIDGE NO.
T200811301	
COUNTY	DESIGNED BY: MFM
NEW CASTLE	CHECKED BY: SKH

PROFILES	SHEET NO.
	129
	TOTAL SHTS.
	850

J:\2008 PROJECTS\3X34801\700CADD\750AET\ROADWAY\PF_301AET_027.DGN

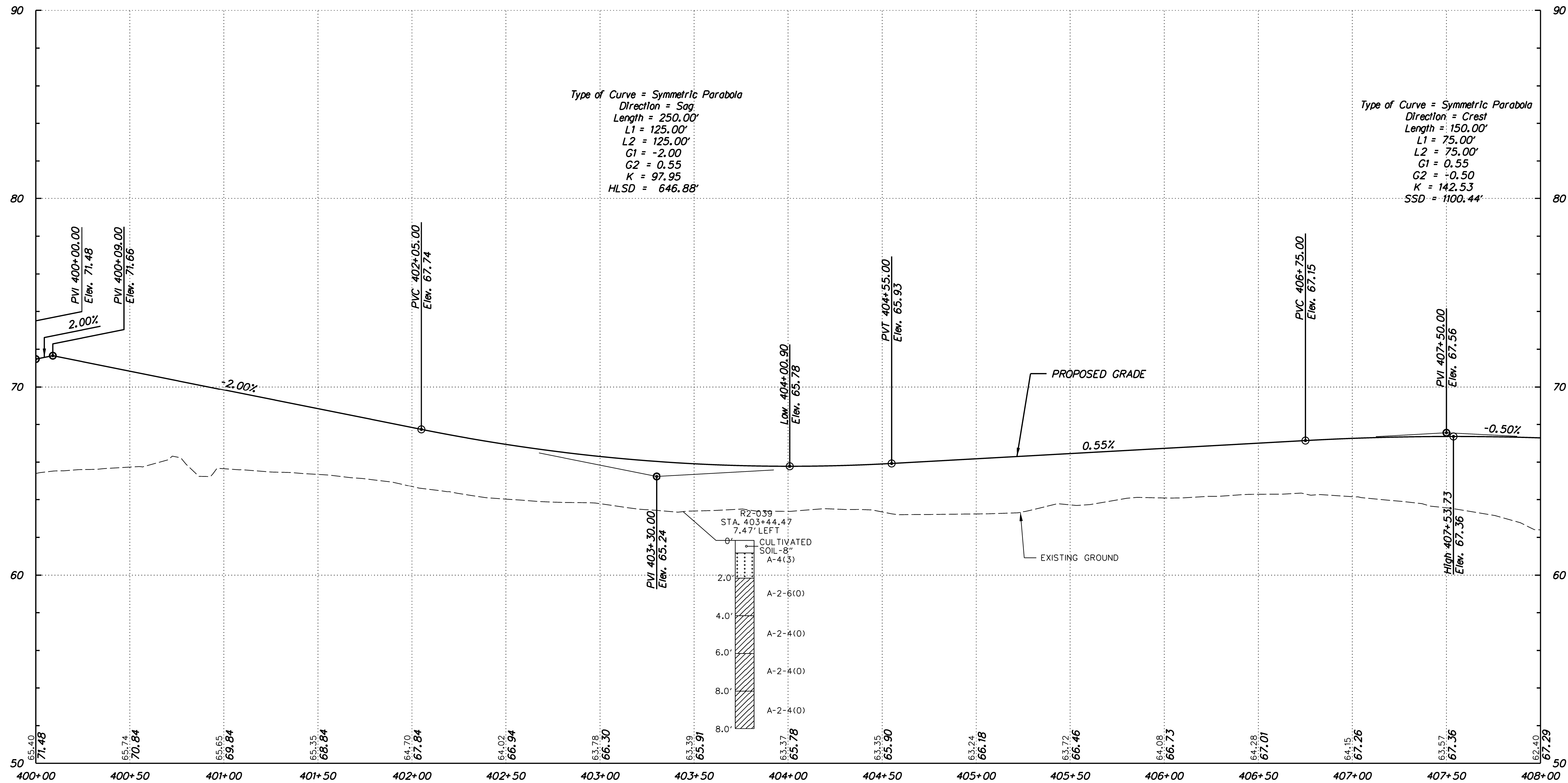

RAMP E

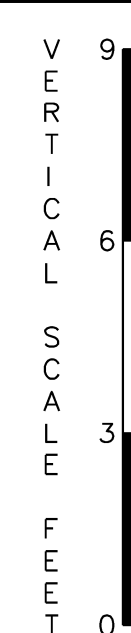

PF-27



ADDENDUMS / REVISIONS	

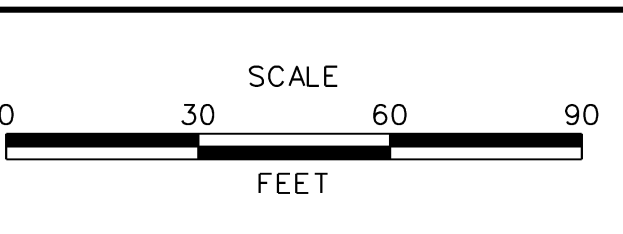

US 301
MARYLAND STATE LINE
TO LEVELS ROAD

CONTRACT	BRIDGE NO.
T200811301	
COUNTY	DESIGNED BY: MFM
NEW CASTLE	CHECKED BY: SKH

PROFILES	SHEET NO.
	130
	TOTAL SHTS.
	850

J:\2008 PROJECTS\34801\700ADD\750AET\ROADWAY\PF_301AET_028.DGN

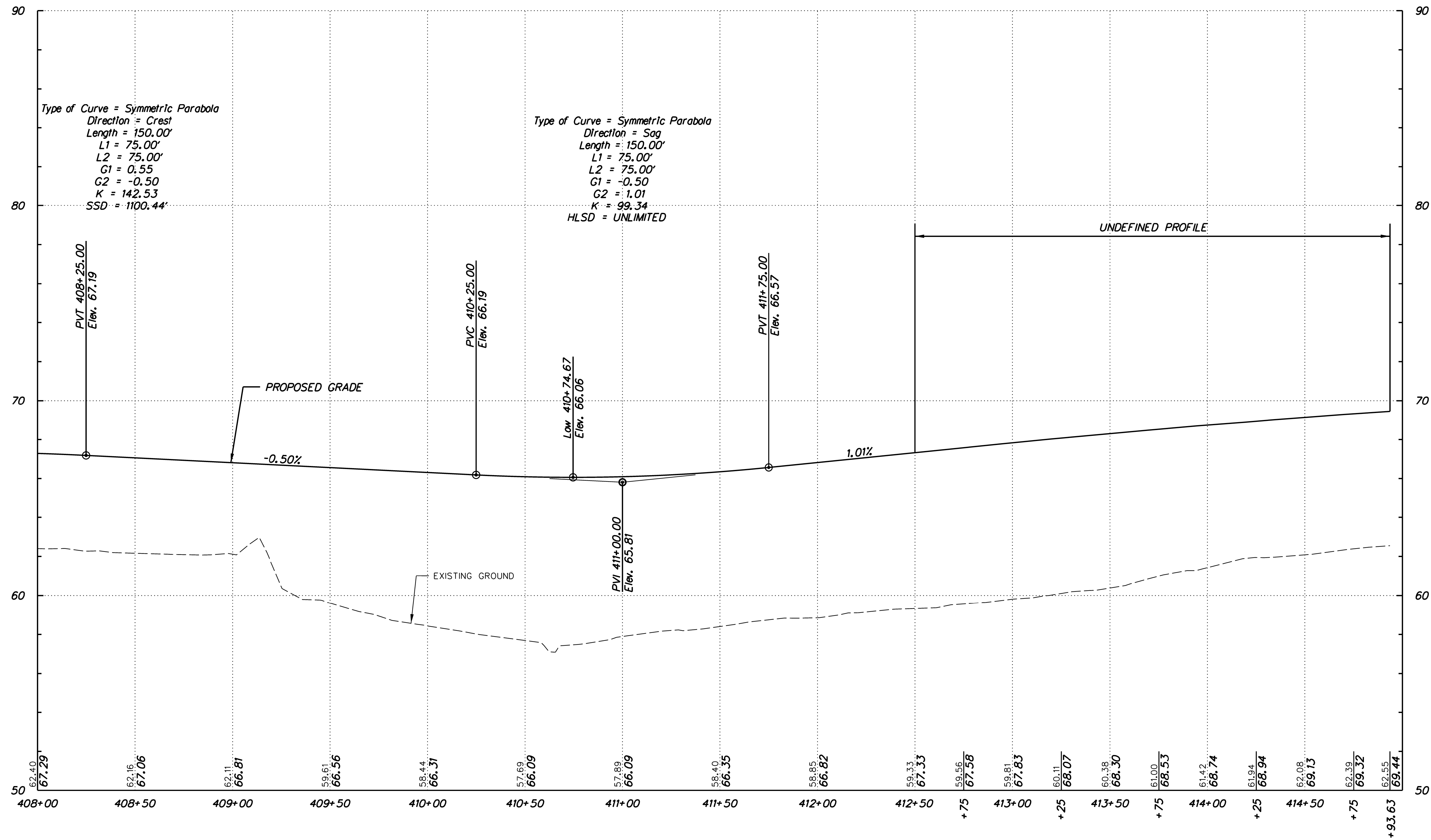

RAMP E

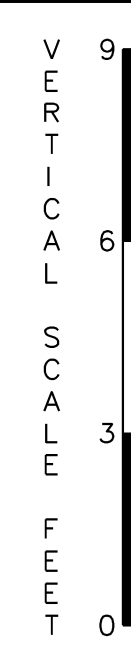

PF-28



ADDENDUMS / REVISIONS	

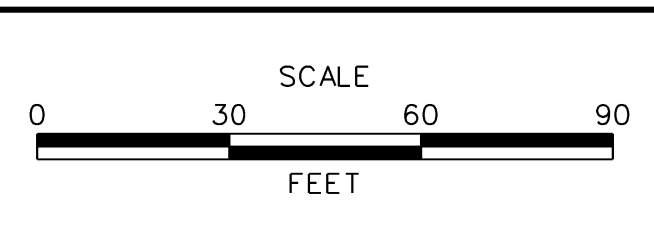

US 301
MARYLAND STATE LINE
TO LEVELS ROAD

CONTRACT T200811301	BRIDGE NO.
COUNTY NEW CASTLE	DESIGNED BY: MFM
	CHECKED BY: SKH

PROFILES	SHEET NO.
	TOTAL SHTS.
	850

Type of Curve = Symmetric Parabola
 Direction = Crest
 Length = 200.00'
 L1 = 100.00'
 L2 = 100.00'
 G1 = -2.00%
 G2 = -2.75%
 SSD = 1545.40'
 K = 267.88

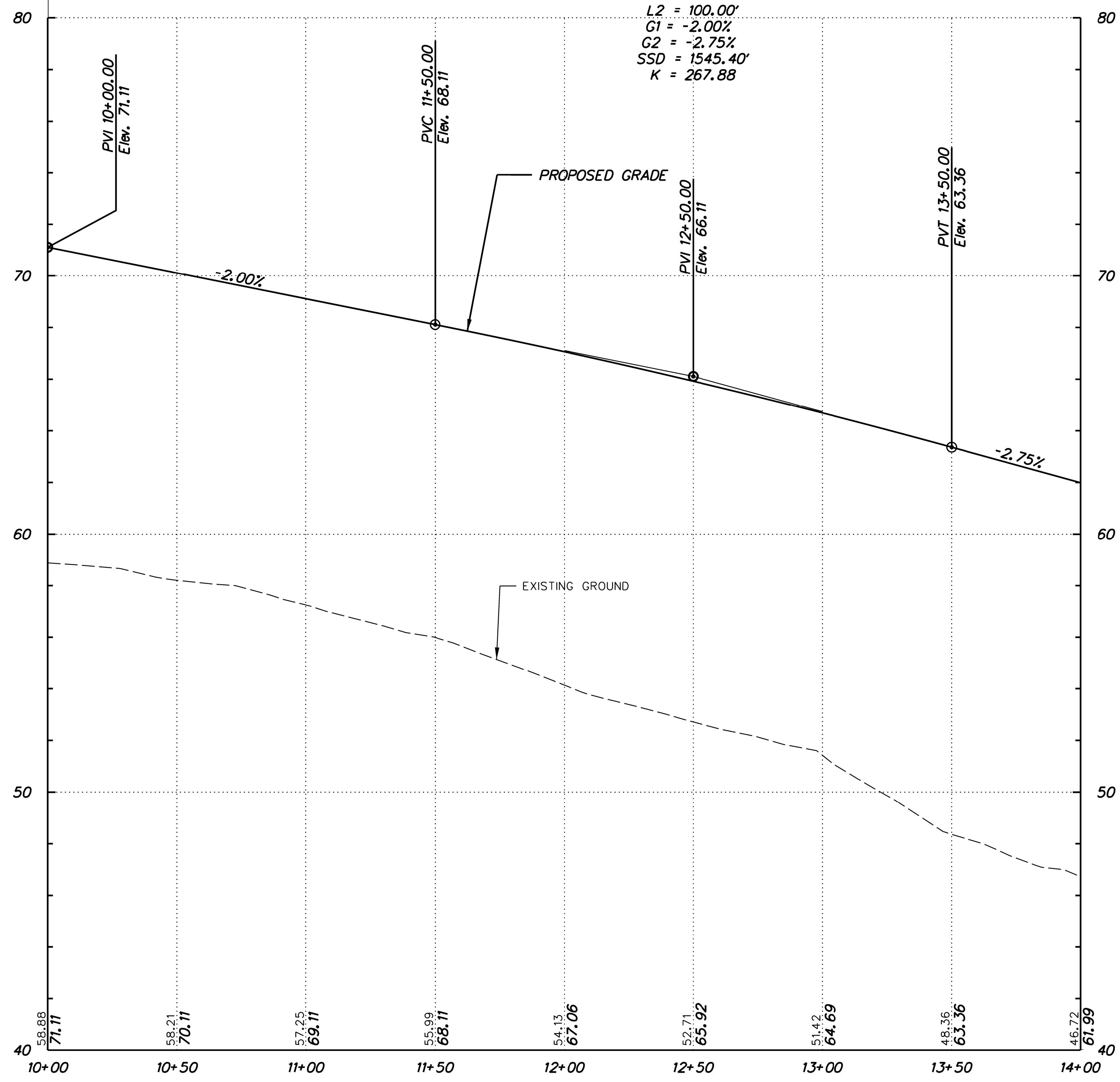

RAMP C

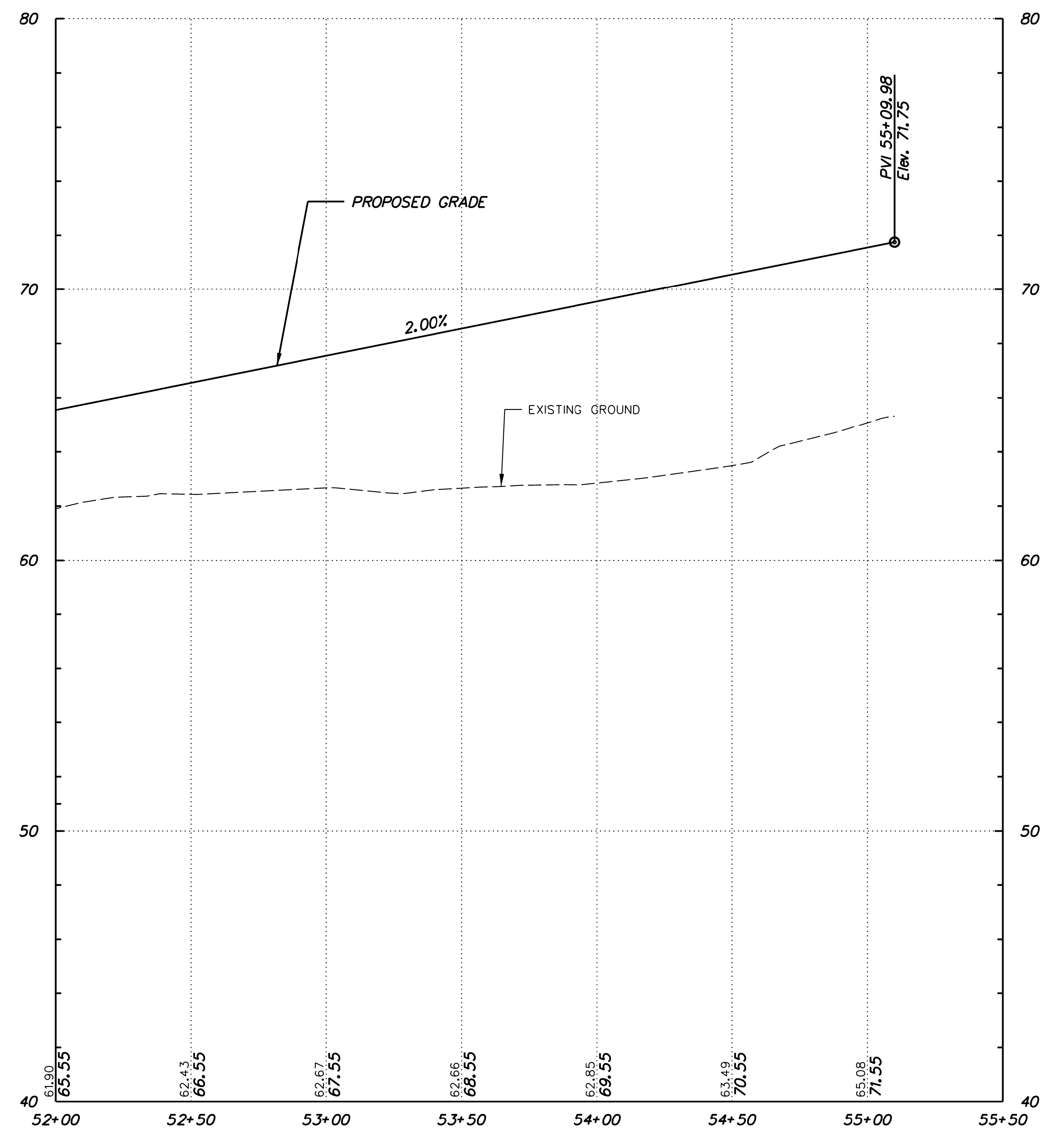

RAMP E

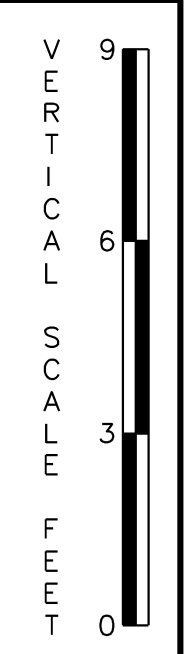

J:\2008 PROJECTS\34801\700CADD\750AET\ROADWAY\PF_301AET_029.DGN



ADDENDUMS / REVISIONS	

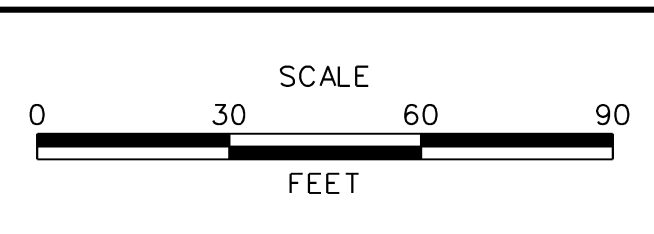

US 301
 MARYLAND STATE LINE
 TO LEVELS ROAD

CONTRACT	BRIDGE NO.
T200811301	
COUNTY	DESIGNED BY: MFM
NEW CASTLE	CHECKED BY: SKH

PROFILES	SHEET NO.
	132
	TOTAL SHTS.
	850

**LIMIT OF CONSTRUCTION
STATION 1001+00**

Type = Symmetric Parabola
 Direction = Sag
 L = 400.00'
 L1 = 200.00'
 L2 = 200.00'
 G1 = 0.36%
 G2 = 6.57%
 E = 3.11'
 K = 64.34
 HLSD = 308.59'

R3-S-01
 STA. 1006+00.00
 0.00' RIGHT
 ASPHALT-6"
 CRUSHER
 RUN-18"
 2.0'

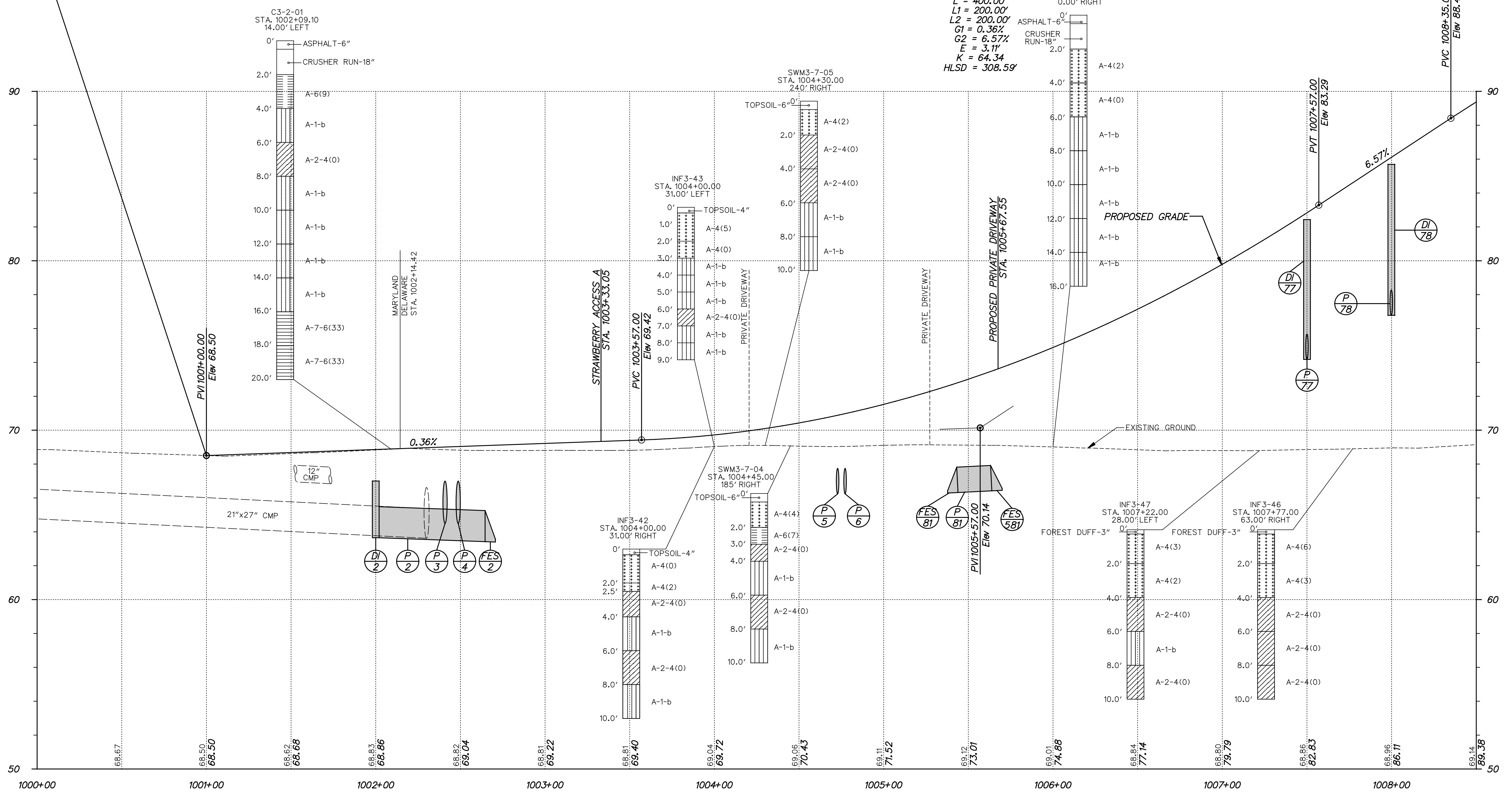

WILSON STREET / STRAWBERRY LANE

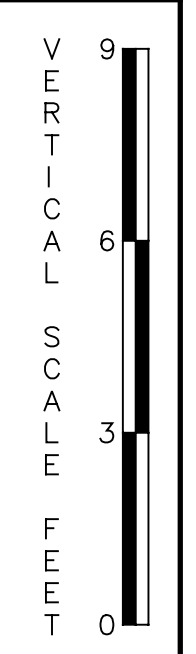

PF-30



ADDENDUMS / REVISIONS	

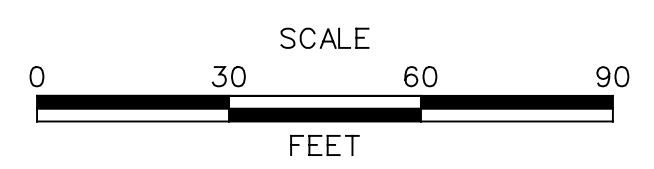

**US 301
 MARYLAND STATE LINE
 TO LEVELS ROAD**

CONTRACT T200811301	BRIDGE NO.
COUNTY NEW CASTLE	DESIGNED BY: MAG/TAM
	CHECKED BY: PAH

PROFILES

SHEET NO. 133
TOTAL SHTS. 850

Type = Symmetric Parabola
 Direction = Crest
 L = 600.00'
 L1 = 300.00'
 L2 = 300.00'
 G1 = 6.57%
 G2 = -6.69%
 E = -9.95'
 K = 45.22
 SSD = 312.42'

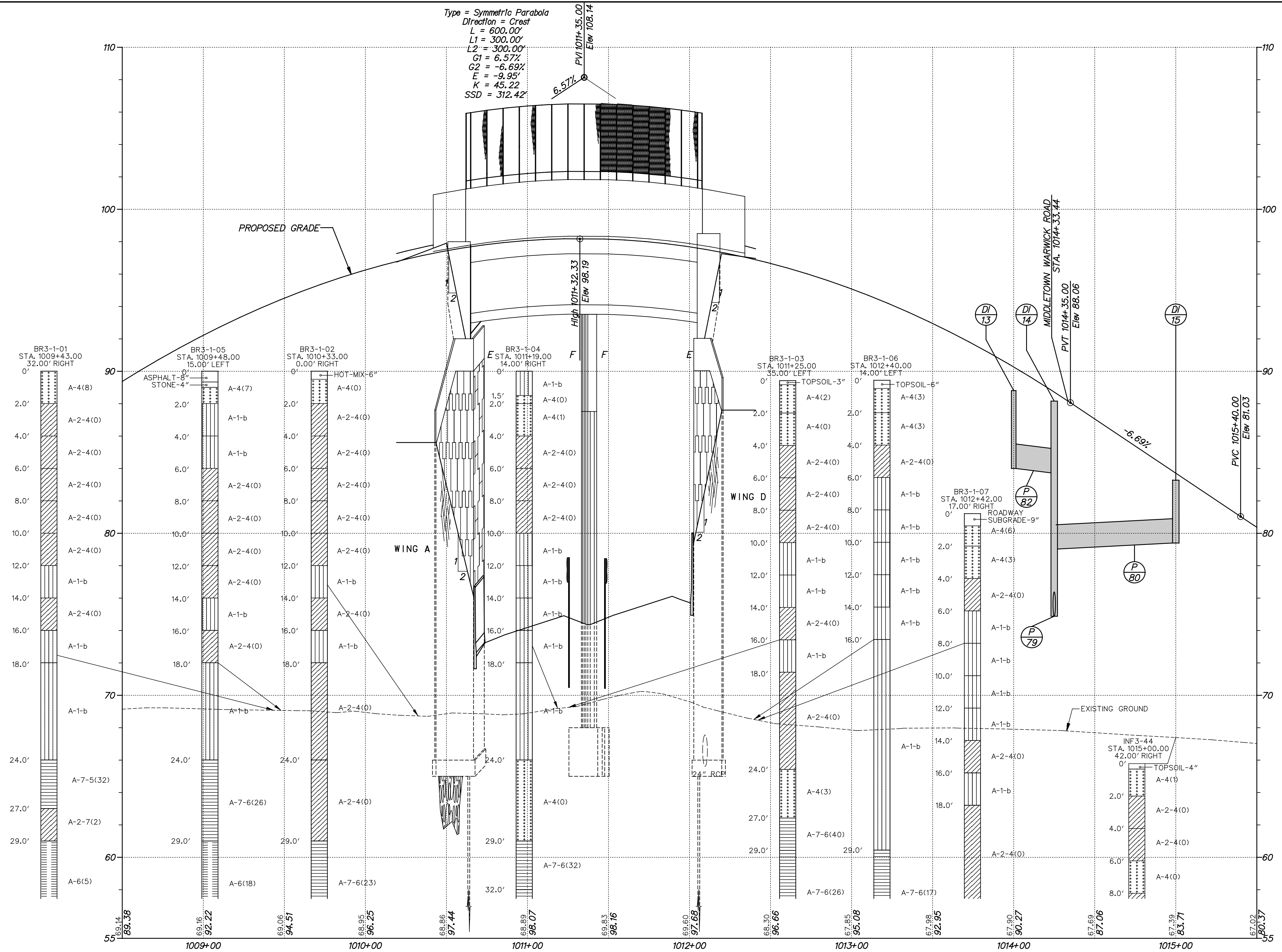

ADDENDUMS / REVISIONS	

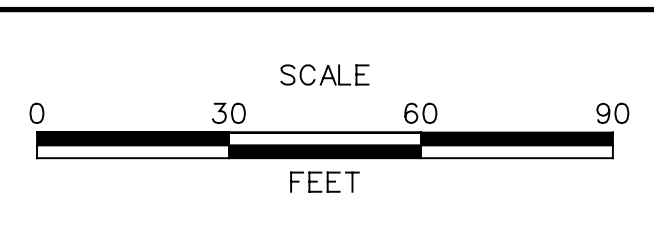

US 301
MARYLAND STATE LINE
TO LEVELS ROAD

CONTRACT	BRIDGE NO.	1-486
T200811301	DESIGNED BY:	MAG/TAM
COUNTY	CHECKED BY:	PAH
NEW CASTLE		

PROFILES	SHEET NO.	134
	TOTAL SHTS.	850

PF-31

Type = Symmetric Parabola
 Direction = Sag
 L = 400.00'
 L1 = 200.00'
 L2 = 200.00'
 G1 = -6.69%
 G2 = -0.36%
 E = 3.17'
 K = 63.16
 HLSD = 304.14'

C3-3-01
 STA. 1019+49.65
 14.00' LEFT

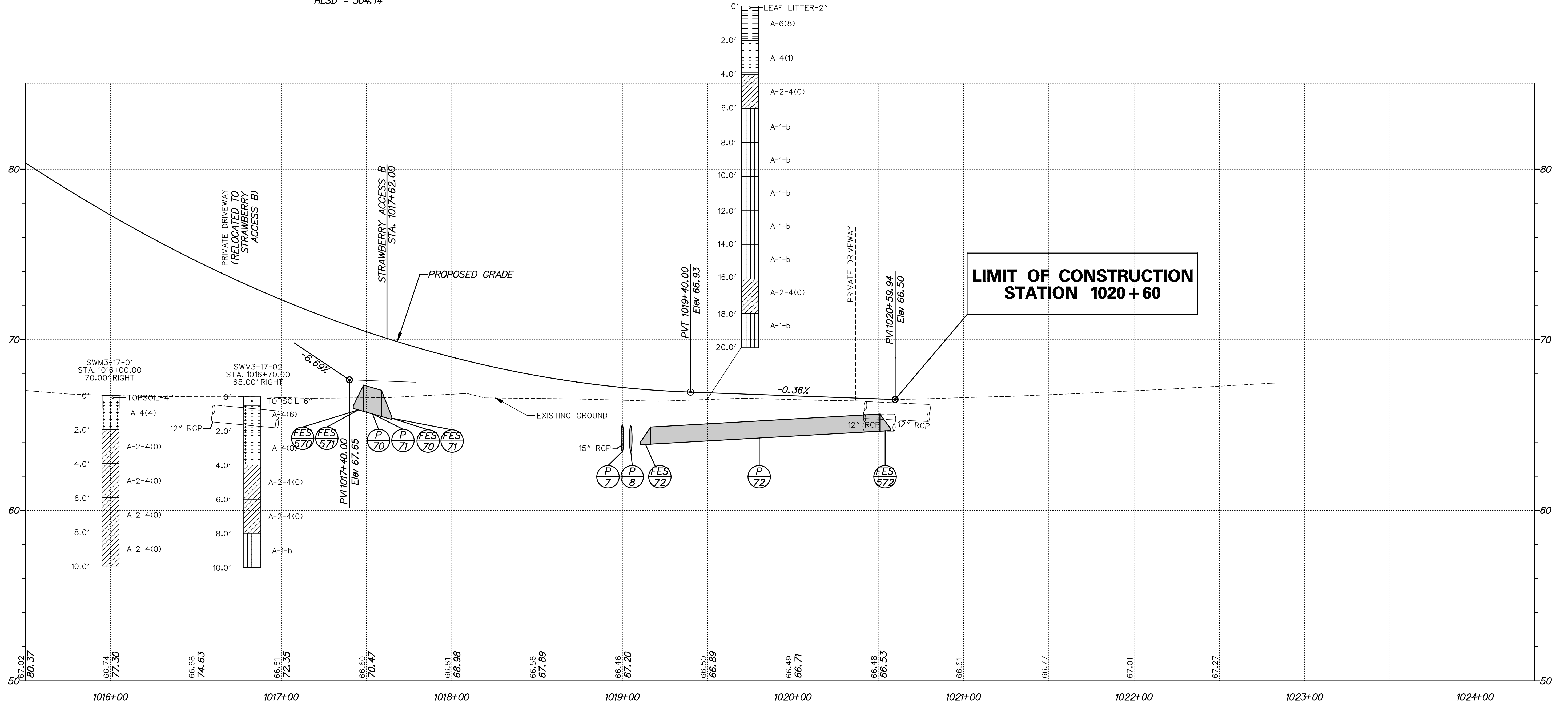

STRAWBERRY LANE

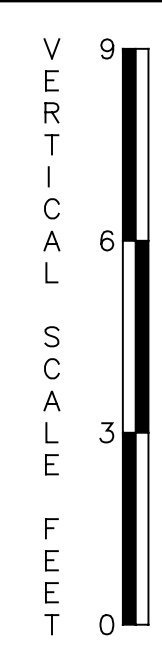

PF-32



ADDENDUMS / REVISIONS	

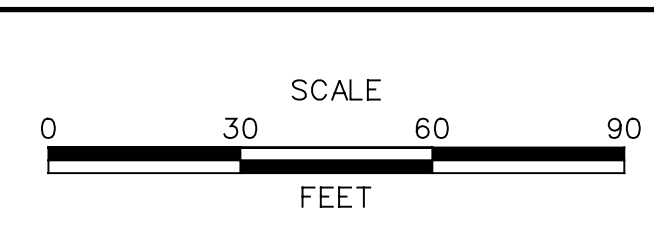

**US 301
 MARYLAND STATE LINE
 TO LEVELS ROAD**

CONTRACT T200811301	BRIDGE NO.
COUNTY NEW CASTLE	DESIGNED BY: MAG/TAM
	CHECKED BY: PAH

PROFILES	SHEET NO. 135
	TOTAL SHTS. 850

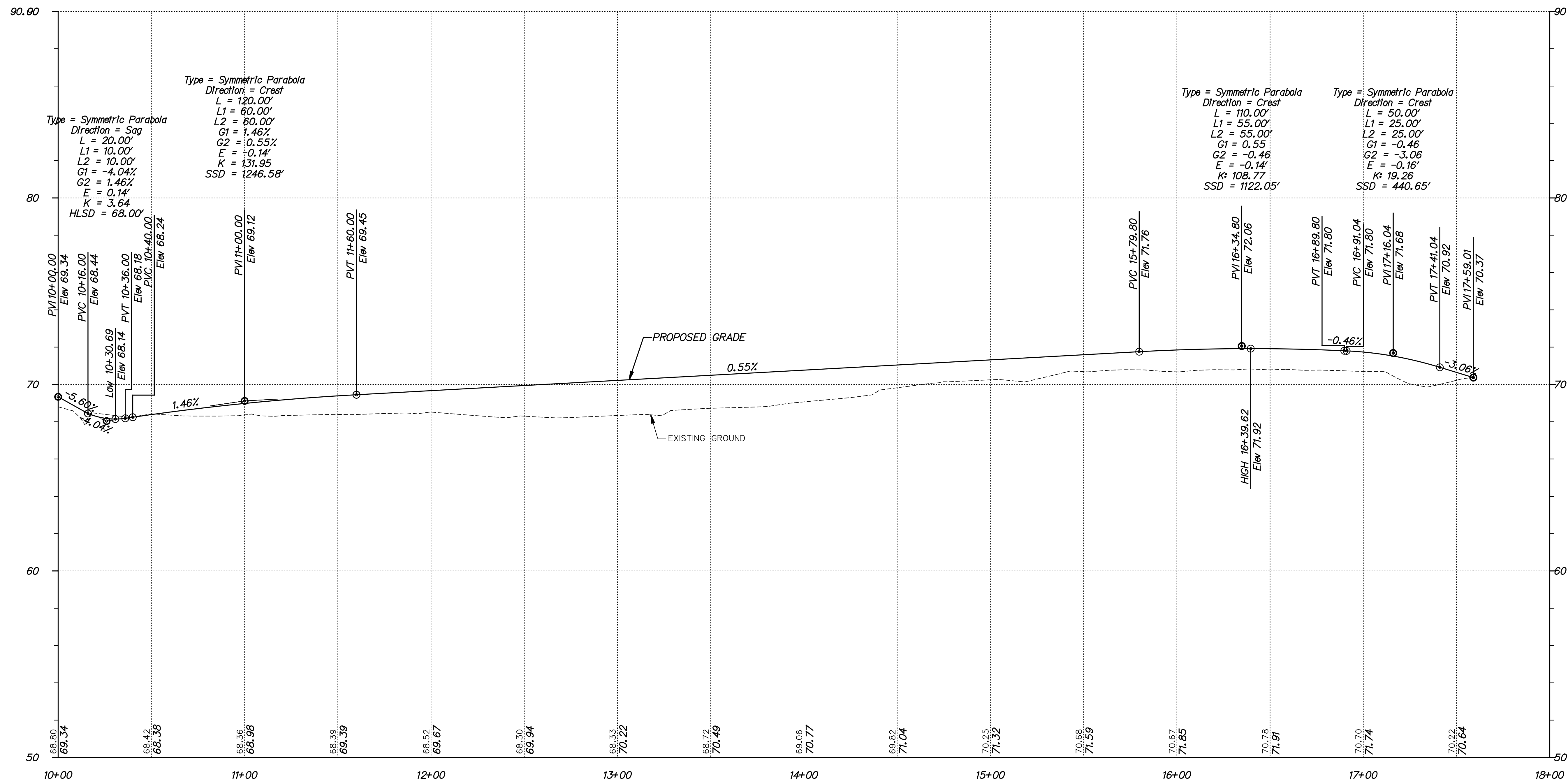

STRAWBERRY ACCESS A



ADDENDUMS / REVISIONS	

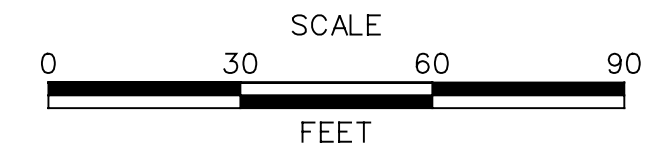

**US 301
MARYLAND STATE LINE
TO LEVELS ROAD**

CONTRACT T200811301	BRIDGE NO.
COUNTY NEW CASTLE	DESIGNED BY: MAG/TAM
	CHECKED BY: PAH

PROFILES

PF-33	SHEET NO. 136
	TOTAL SHTS. 850

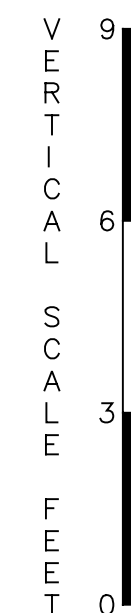

Type = Symmetric Parabola
 Direction = Sag
 L = 50.00'
 L1 = 25.00'
 L2 = 25.00'
 G1 = -4.00
 G2 = -1.24
 E = 0.17'
 K = 18.09
 HLSD = 265.56'

Type = Symmetric Parabola
 Direction = Sag
 L = 50.00'
 L1 = 25.00'
 L2 = 25.00'
 G1 = -1.24
 G2 = -0.50
 E = 0.05'
 K = 67.97
 HLSD > 305.00'

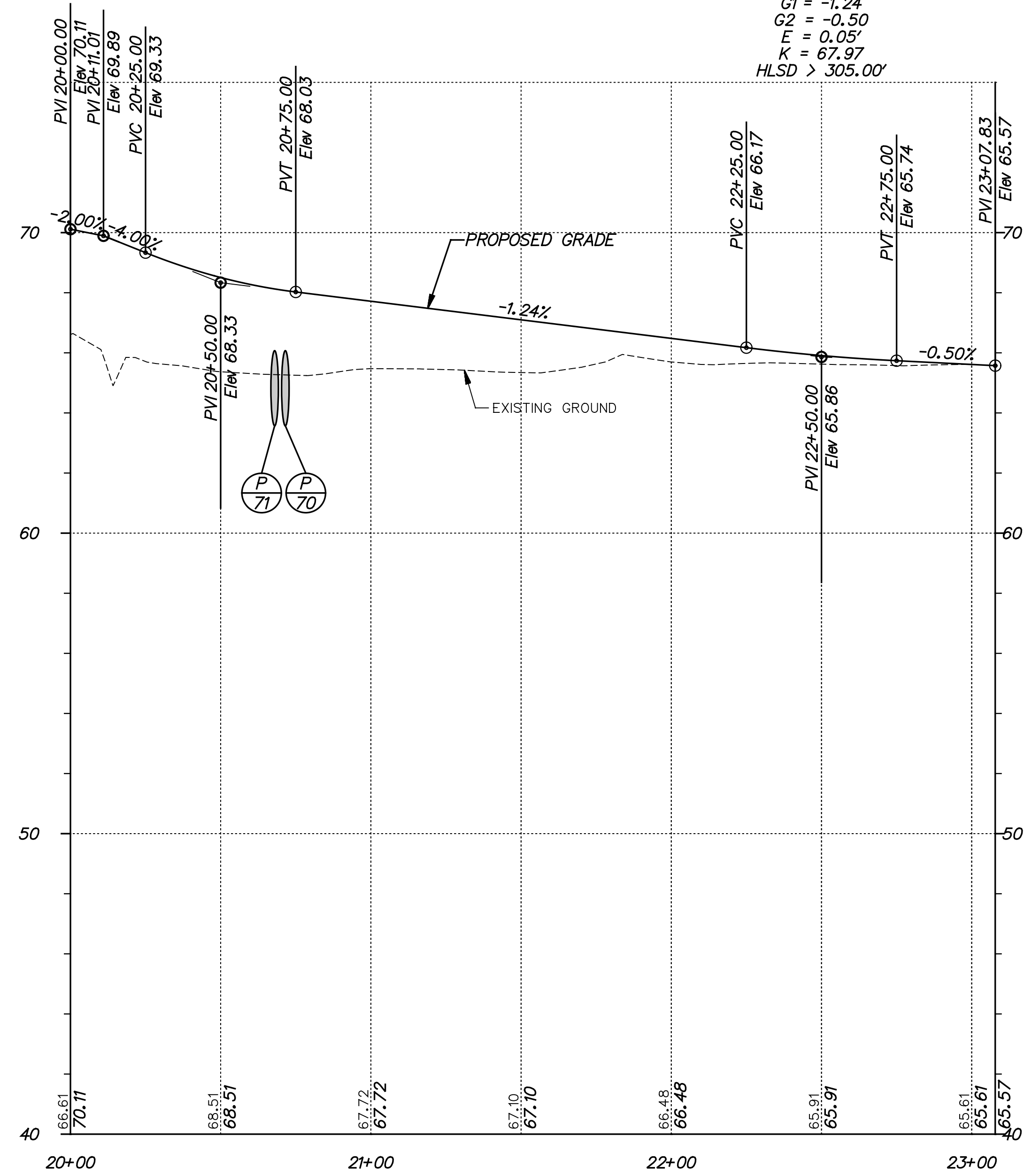

STRAWBERRY ACCESS B

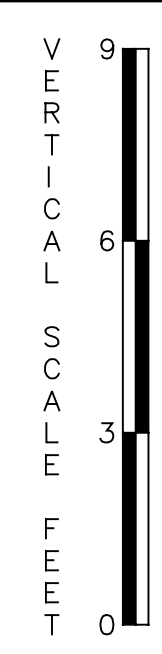

PF-34

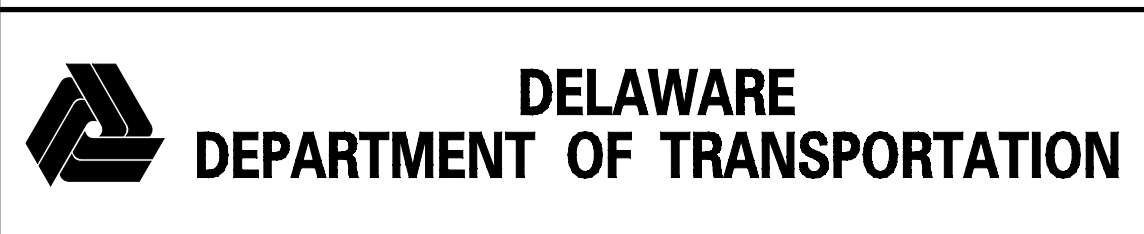

ADDENDUMS / REVISIONS	

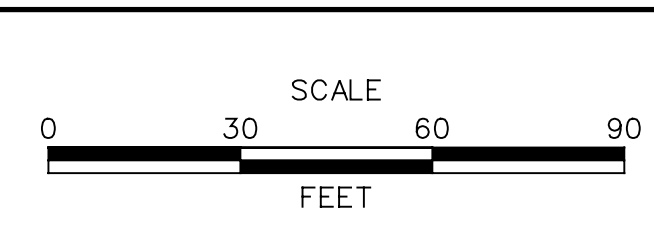

**US 301
 MARYLAND STATE LINE
 TO LEVELS ROAD**

CONTRACT	BRIDGE NO.
T200811301	
COUNTY	DESIGNED BY: MAG/TAM
NEW CASTLE	CHECKED BY: PAH

PROFILES

SHEET NO.
137
TOTAL SHTS.
850

J:\2008 PROJECTS\3X34801\700CADD\750AET\ROADWAY\PF_301AET_035.DGN

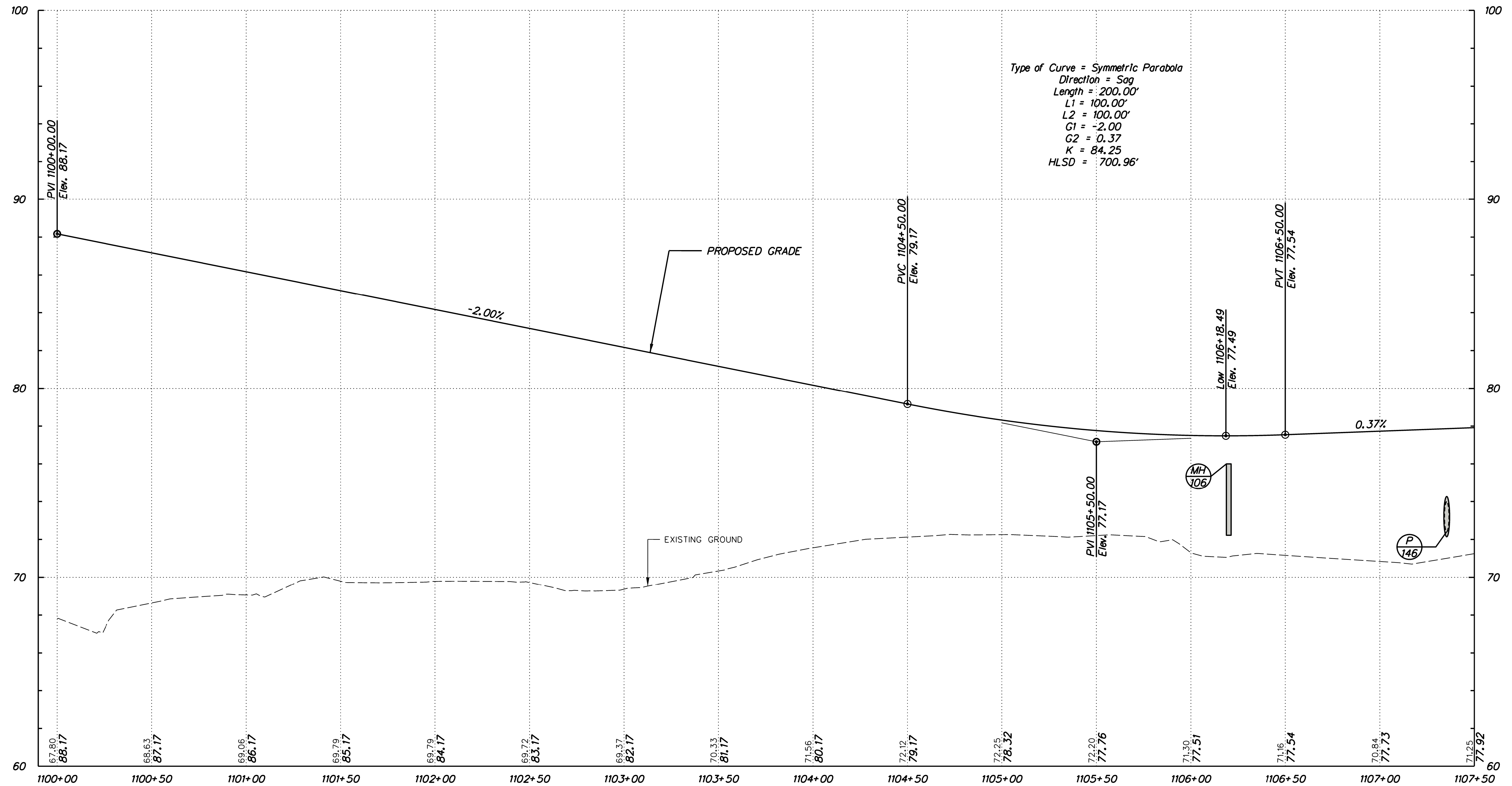

MIDDLETOWN WARWICK ROAD

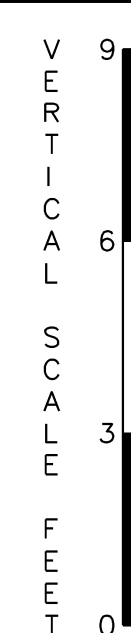

PF-35



ADDENDUMS / REVISIONS	

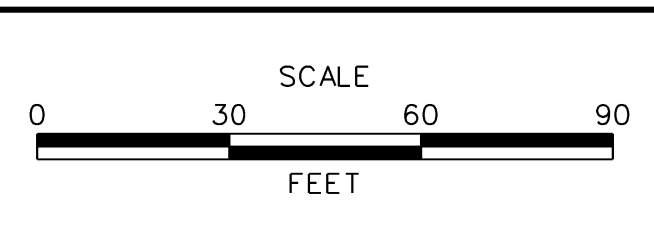

US 301
MARYLAND STATE LINE
TO LEVELS ROAD

CONTRACT	BRIDGE NO.
T200811301	
COUNTY	DESIGNED BY: MFM
NEW CASTLE	CHECKED BY: SKH

PROFILES	SHEET NO.
	138
	TOTAL SHTS.
	850

J:\2008 PROJECTS\3X34801\700CADD\750AET\ROADWAY\PF_301AET_036.DGN

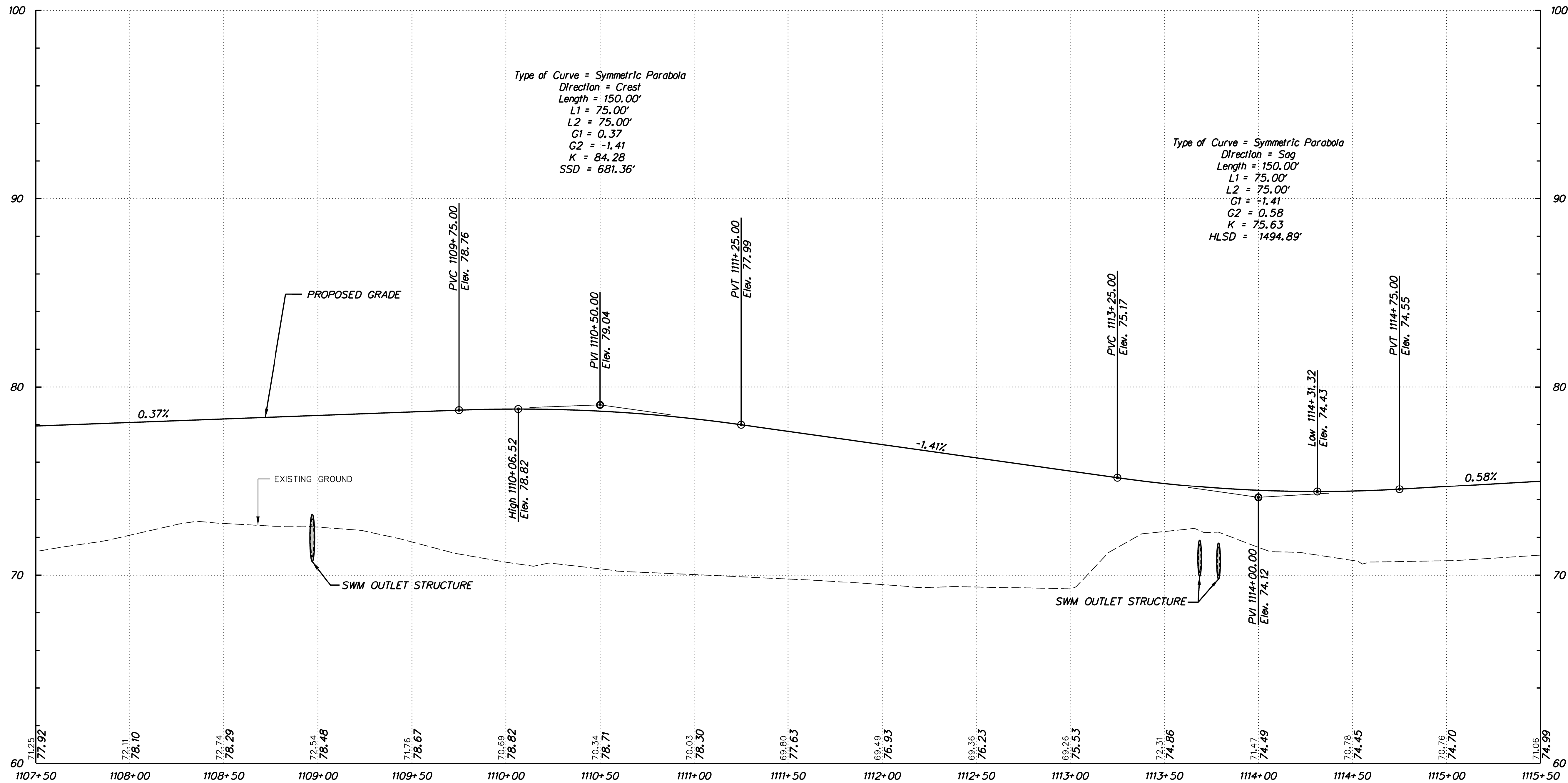

MIDDLETOWN WARWICK ROAD

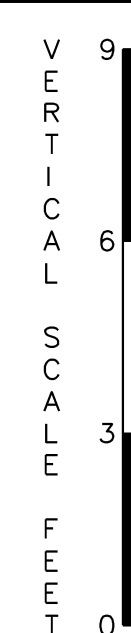

PF-36



ADDENDUMS / REVISIONS	

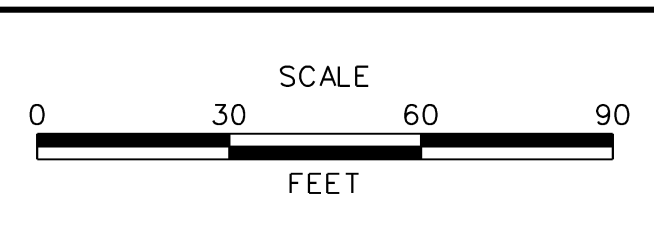

US 301
MARYLAND STATE LINE
TO LEVELS ROAD

CONTRACT	BRIDGE NO.
T200811301	
COUNTY	DESIGNED BY: MFM
NEW CASTLE	CHECKED BY: SKH

PROFILES

SHEET NO.
139
TOTAL SHTS.
850

J:\2008 PROJECTS\3X34801\700CADD\750AET\ROADWAY\PF_301AET_037.DGN

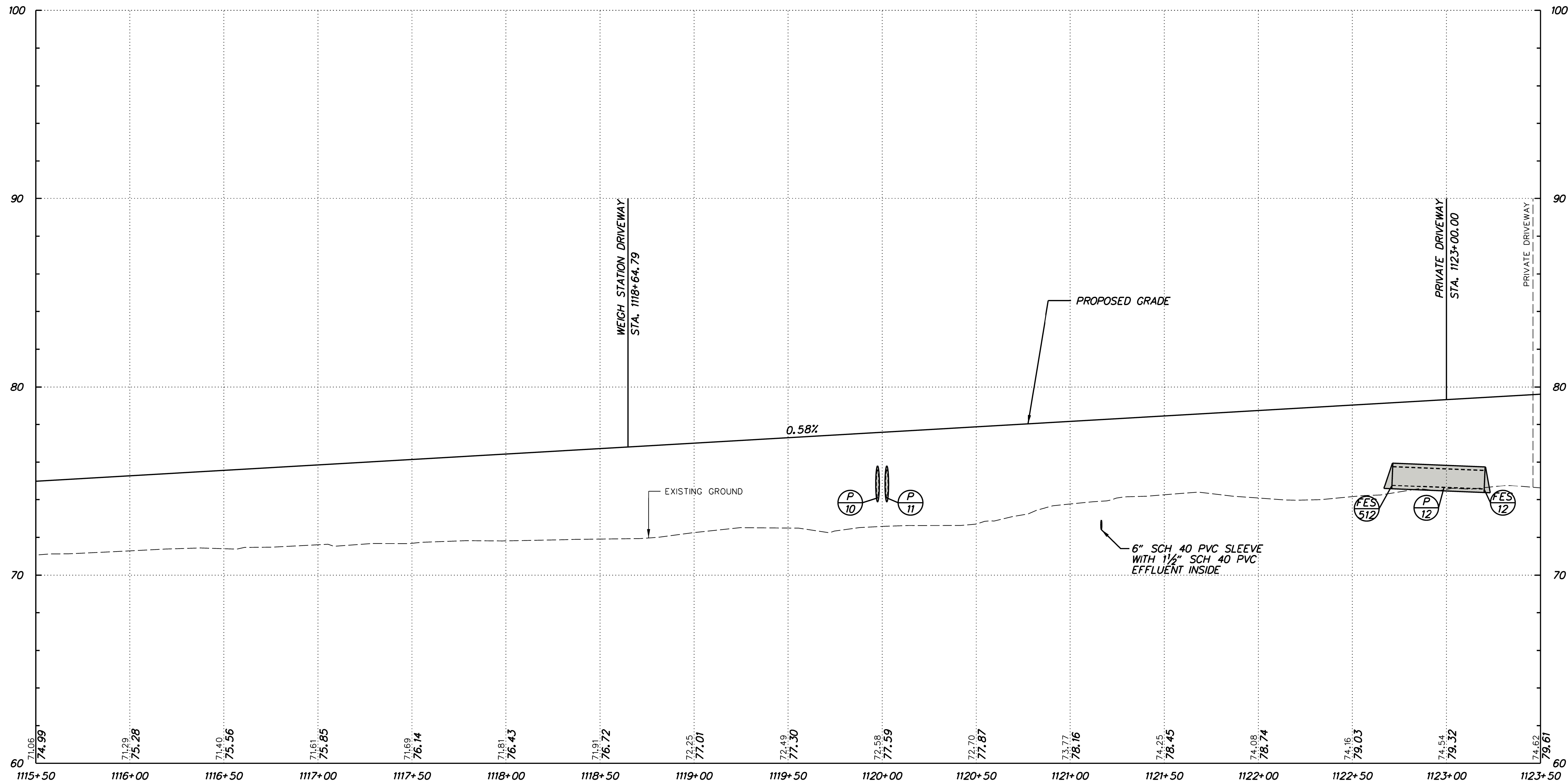

MIDDLETOWN WARWICK ROAD



ADDENDUMS / REVISIONS

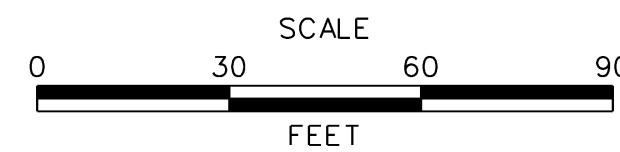

US 301
MARYLAND STATE LINE
TO LEVELS ROAD

CONTRACT	BRIDGE NO.
T200811301	
COUNTY	DESIGNED BY: MFM
NEW CASTLE	CHECKED BY: SKH

PROFILES

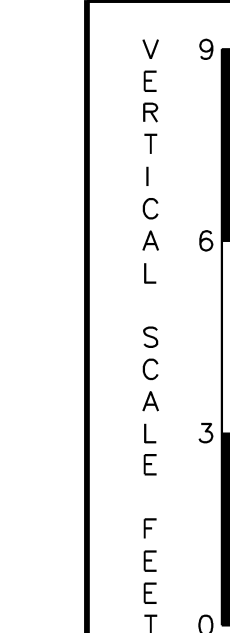

PF-37

SHEET NO.
140
TOTAL SHTS.
850

J:\2008 PROJECTS\334801\700CADD\750AET\ROADWAY\PF_301AET_038.DGN

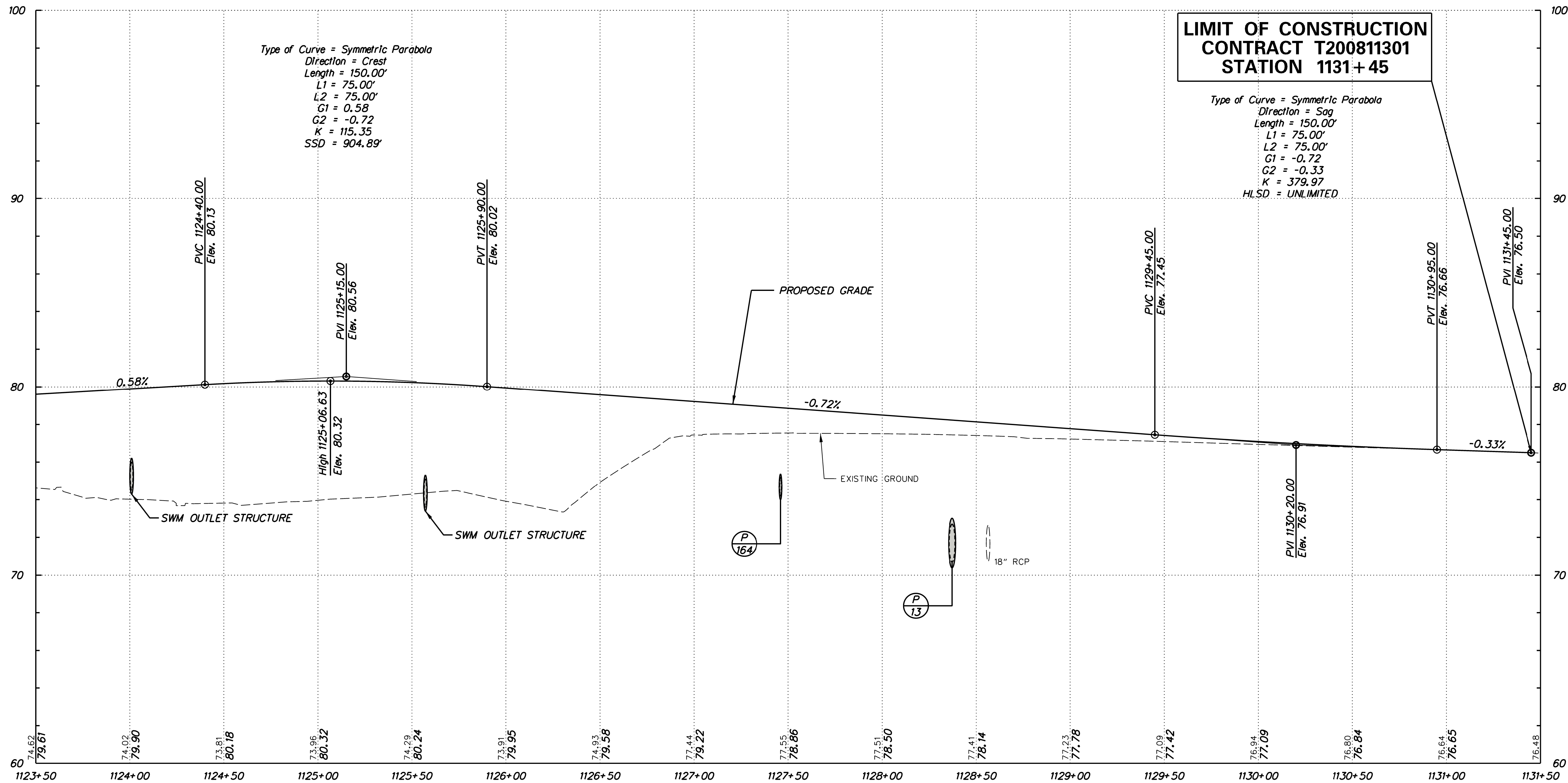

**LIMIT OF CONSTRUCTION
CONTRACT T200811301
STATION 1131+45**

Type of Curve = Symmetric Parabola
Direction = Crest
Length = 150.00'
L1 = 75.00'
L2 = 75.00'
G1 = 0.58
G2 = -0.72
K = 115.35
SSD = 904.89'

Type of Curve = Symmetric Parabola
Direction = Sag
Length = 150.00'
L1 = 75.00'
L2 = 75.00'
G1 = -0.72
G2 = -0.33
K = 379.97
HLSD = UNLIMITED

MIDDLETOWN WARWICK ROAD

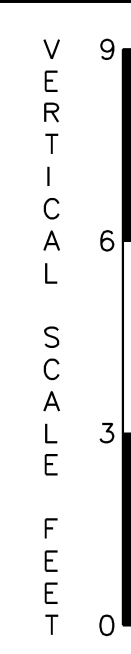

PF-38



ADDENDUMS / REVISIONS	

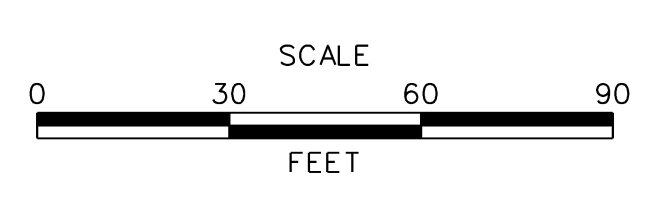

**US 301
MARYLAND STATE LINE
TO LEVELS ROAD**

CONTRACT T200811301	BRIDGE NO.
COUNTY NEW CASTLE	DESIGNED BY: MFM
	CHECKED BY: SKH

PROFILES

SHEET NO.	141
TOTAL SHTS.	850

J:\2008 PROJECTS\34801\7000ADD\750AET\ROADWAY\PF_30\AET_039.DGN

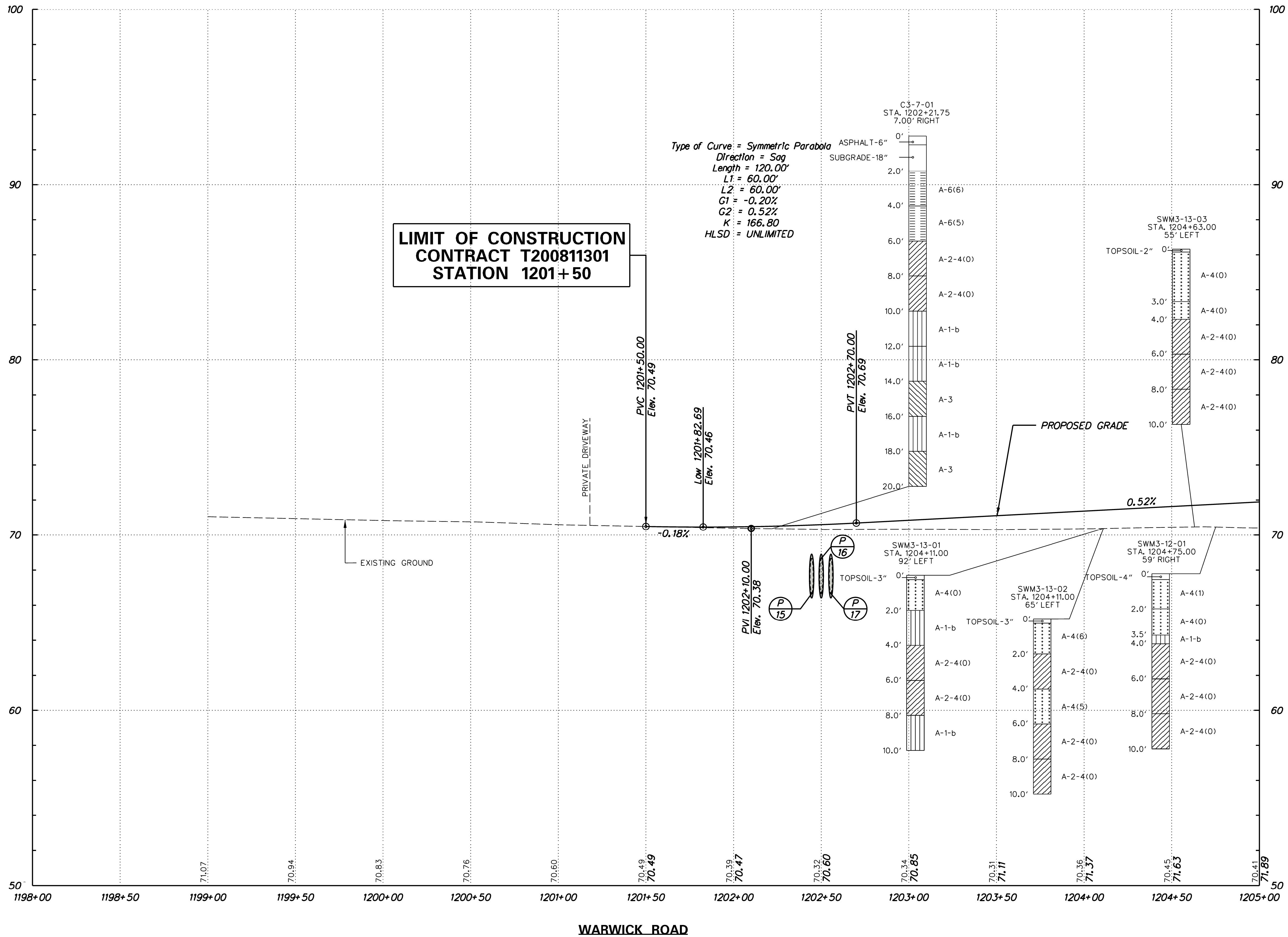

**LIMIT OF CONSTRUCTION
CONTRACT T200811301
STATION 1201+50**



ADDENDUMS / REVISIONS	

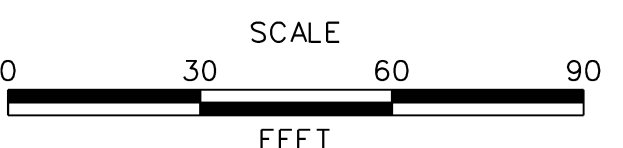

**US 301
MARYLAND STATE LINE
TO LEVELS ROAD**

CONTRACT	BRIDGE NO.
T200811301	
COUNTY	DESIGNED BY: MFM
NEW CASTLE	CHECKED BY: SKH

PROFILES

PF-39	SHEET NO.
	142
	TOTAL SHTS.
	850

J:\2008 PROJECTS\334801\700CADD\750AET\ROADWAY\PF_301AET_040.DGN

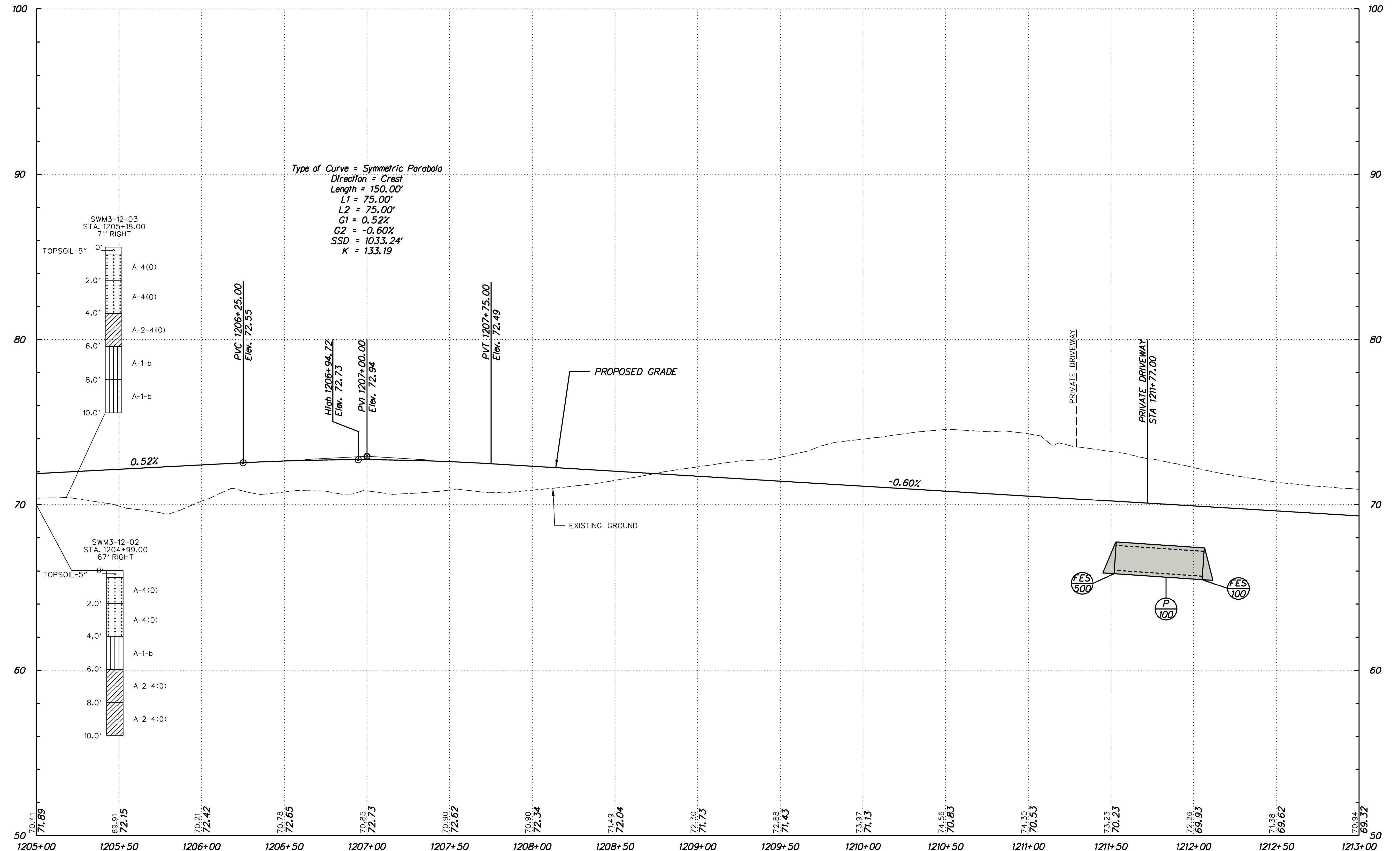

WARWICK ROAD

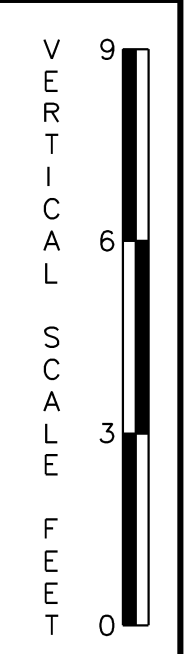

PF-40



ADDENDUMS / REVISIONS	

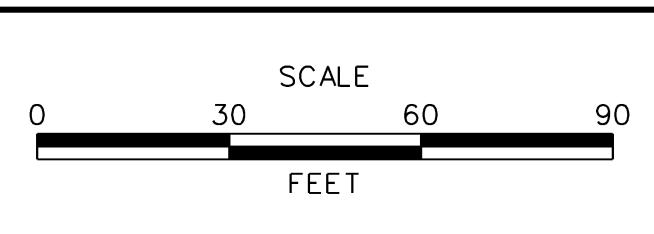

US 301
 MARYLAND STATE LINE
 TO LEVELS ROAD

CONTRACT	BRIDGE NO.
T200811301	
COUNTY	DESIGNED BY: MFM
NEW CASTLE	CHECKED BY: SKH

PROFILES	SHEET NO.
	143
	TOTAL SHTS.
	850

J:\2008 PROJECTS\334801\700CADD\750AET\ROADWAY\PF_30\AET_041.DGN

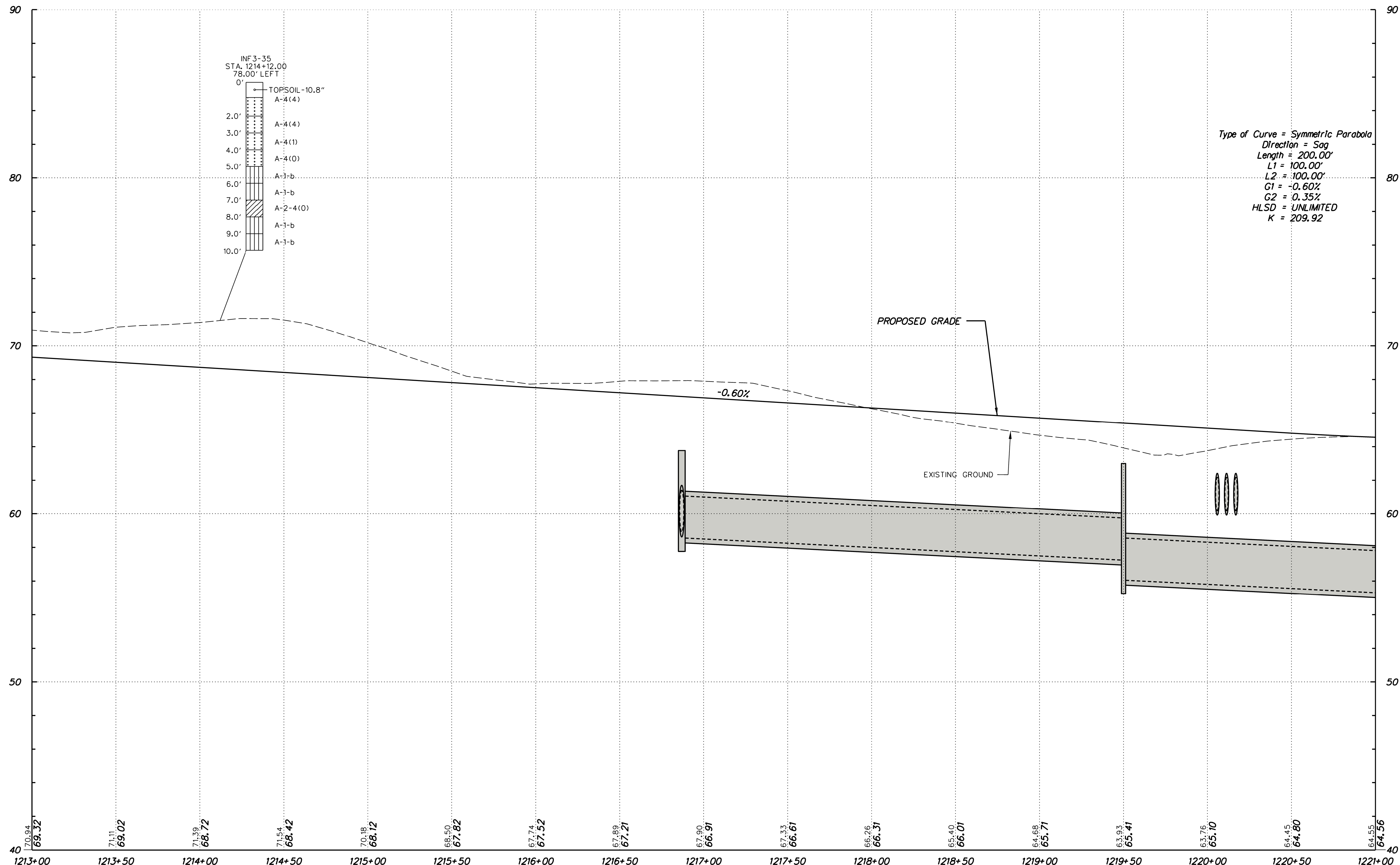

WARWICK ROAD

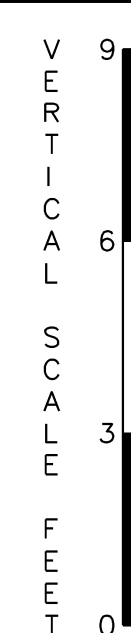

PF-41



ADDENDUMS / REVISIONS	

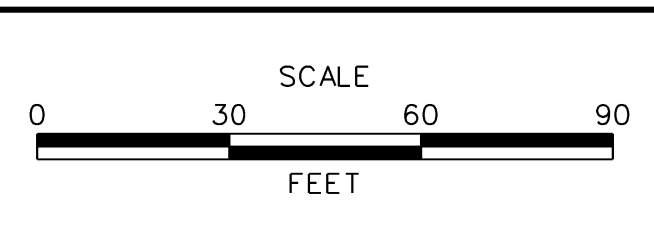

US 301
MARYLAND STATE LINE
TO LEVELS ROAD

CONTRACT	BRIDGE NO.
T200811301	
COUNTY	DESIGNED BY: MFM
NEW CASTLE	CHECKED BY: SKH

PROFILES	SHEET NO.
	144
	TOTAL SHTS.
	850

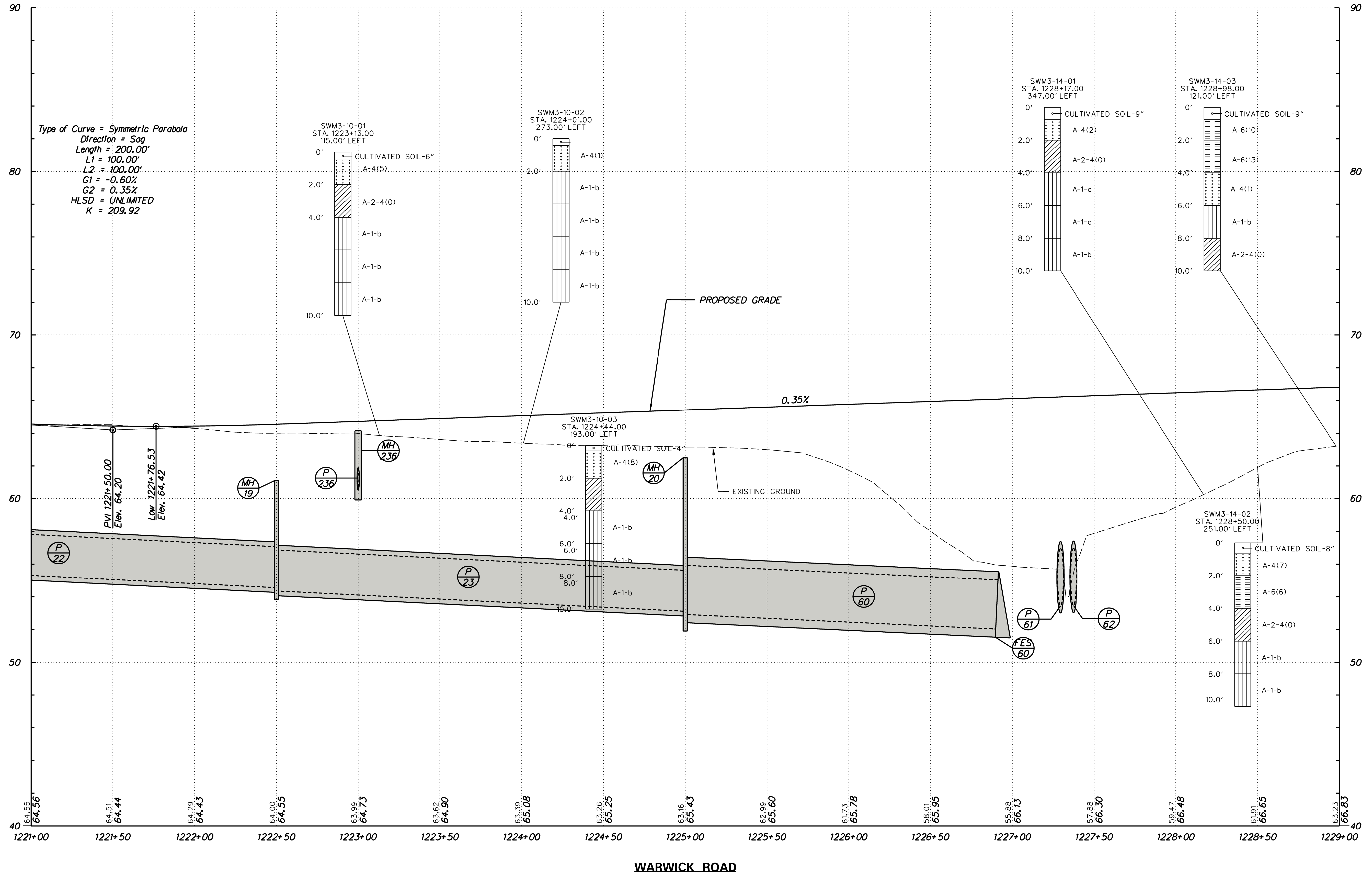

Type of Curve = Symmetric Parabola
 Direction = Sag
 Length = 200.00'
 L1 = 100.00'
 L2 = 100.00'
 G1 = -0.60%
 G2 = 0.35%
 HLSD = UNLIMITED
 K = 209.92

64.56	64.51	64.29	64.00	63.99	63.62	63.39	63.26	63.16	62.99	61.73	58.01	55.88	57.88	59.47	61.91	63.23
1221+00	1221+50	1222+00	1222+50	1223+00	1223+50	1224+00	1224+50	1225+00	1225+50	1226+00	1226+50	1227+00	1227+50	1228+00	1228+50	1229+00

WARWICK ROAD

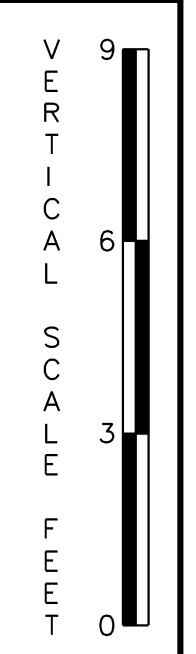

J:\2008 PROJECTS\334801\700CADD\750AET\ROADWAY\PF_30\AET_042.DGN



ADDENDUMS / REVISIONS	

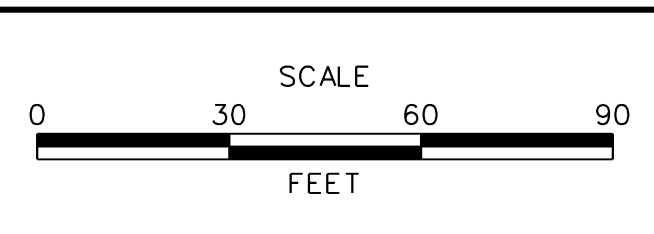

US 301
 MARYLAND STATE LINE
 TO LEVELS ROAD

CONTRACT	BRIDGE NO.
T200811301	
COUNTY	DESIGNED BY: MFM
NEW CASTLE	CHECKED BY: SKH

PROFILES	SHEET NO.
	145
	TOTAL SHTS.
	850

PF-42

J:\2008 PROJECTS\3X34801\750AET\ROADWAY\PF_30\AET_043.DGN

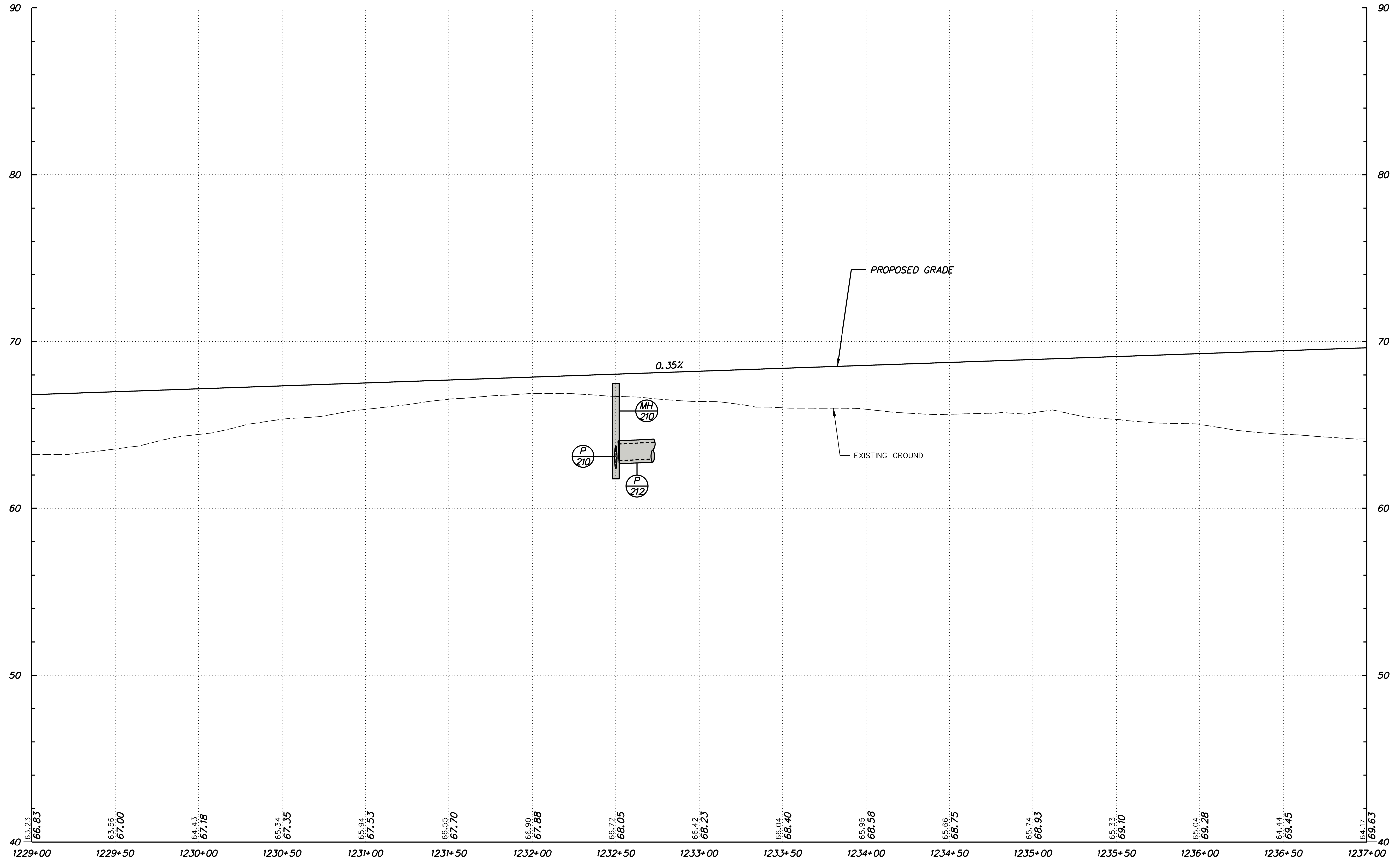

WARWICK ROAD

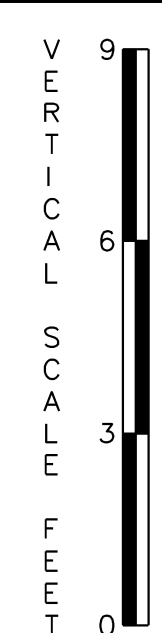

PF-43



ADDENDUMS / REVISIONS	

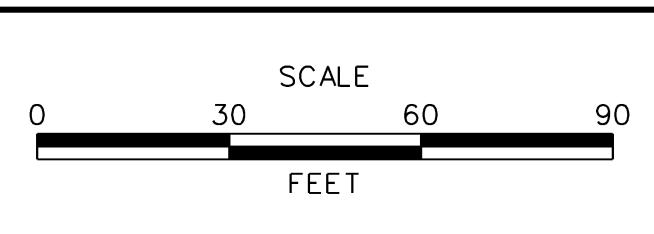

US 301
MARYLAND STATE LINE
TO LEVELS ROAD

CONTRACT	BRIDGE NO.
T200811301	
COUNTY	DESIGNED BY: MFM
NEW CASTLE	CHECKED BY: SKH

PROFILES	SHEET NO.
	146
	TOTAL SHTS.
	850

J:\2008 PROJECTS\334801\700CADD\750AET\ROADWAY\PF_30\AET_044.DGN

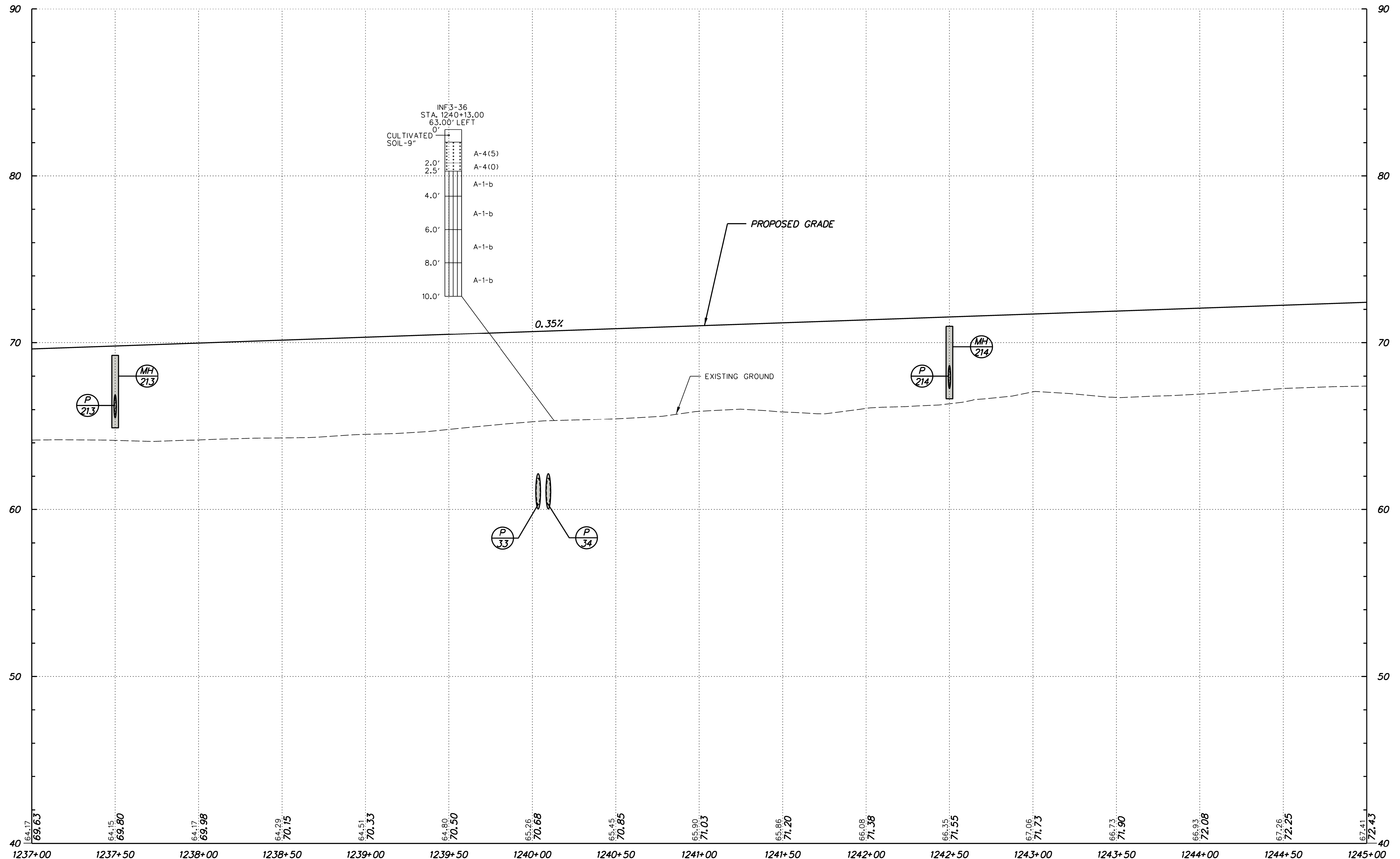

WARWICK ROAD

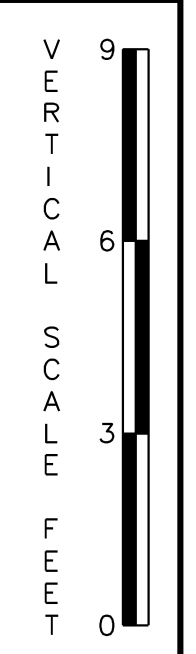

PF-44



ADDENDUMS / REVISIONS	

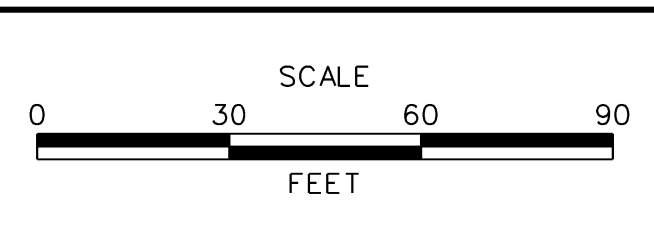

US 301 MARYLAND STATE LINE TO LEVELS ROAD

CONTRACT	BRIDGE NO.
T200811301	
COUNTY	DESIGNED BY: MFM
NEW CASTLE	CHECKED BY: SKH

PROFILES	SHEET NO.
	147
	TOTAL SHTS.
	850

J:\2008 PROJECTS\334801\700CADD\750AET\ROADWAY\PF_301AET_045.DGN

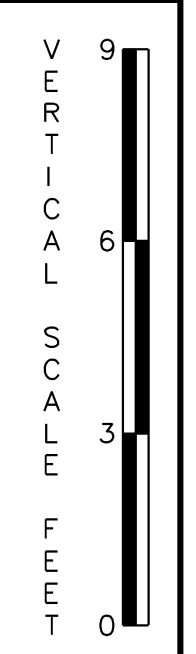
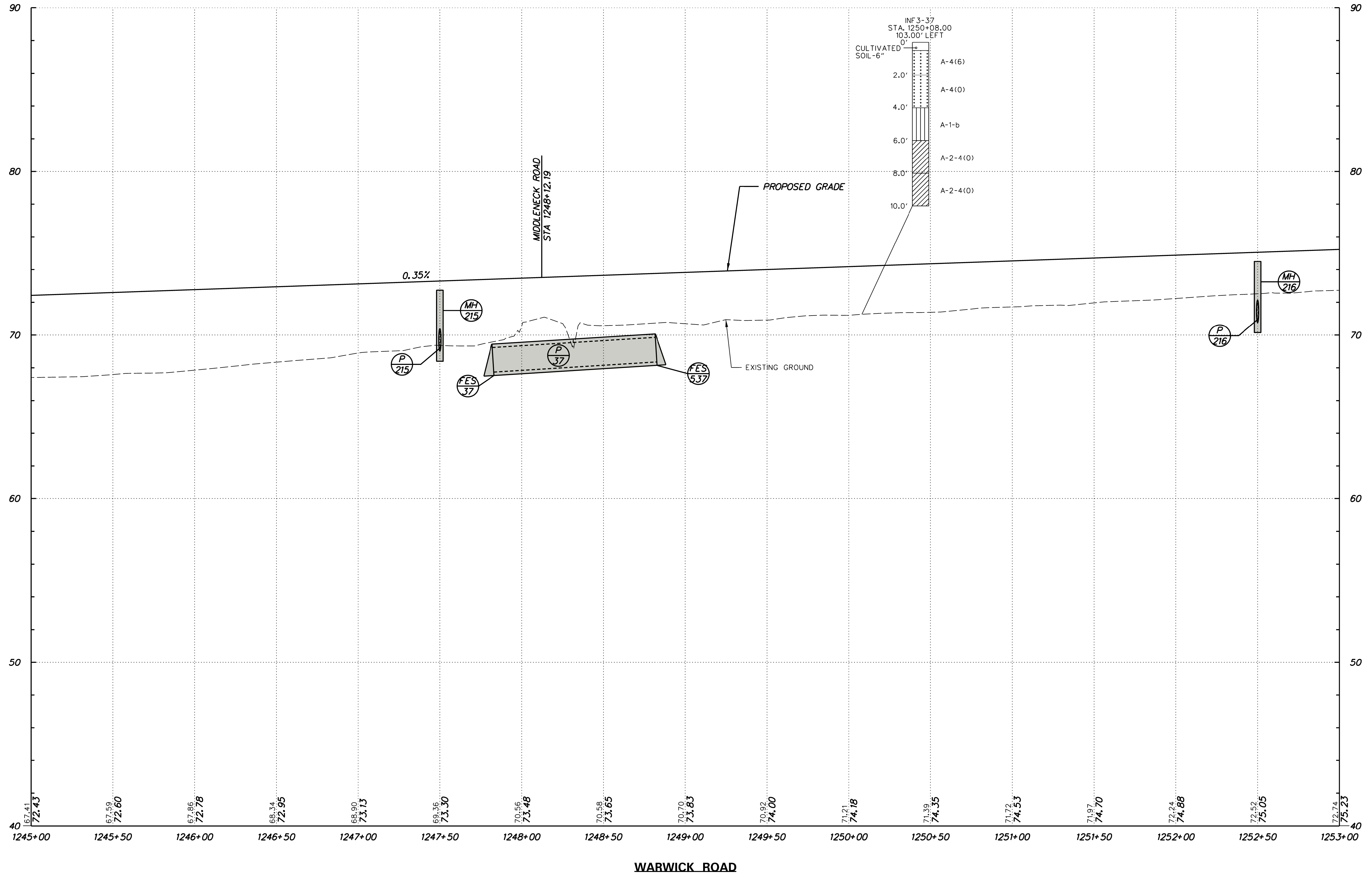

PF-45



ADDENDUMS / REVISIONS	

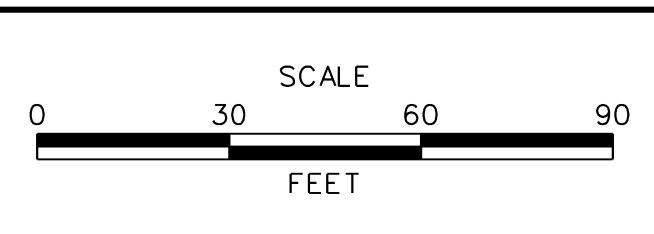

US 301
MARYLAND STATE LINE
TO LEVELS ROAD

CONTRACT	BRIDGE NO.
T200811301	
COUNTY	DESIGNED BY: MFM
NEW CASTLE	CHECKED BY: SKH

PROFILES

SHEET NO.
148
TOTAL SHTS.
850

J:\2008 PROJECTS\3X34801\700CADD\750AET\ROADWAY\PF_30\AET_046.DGN

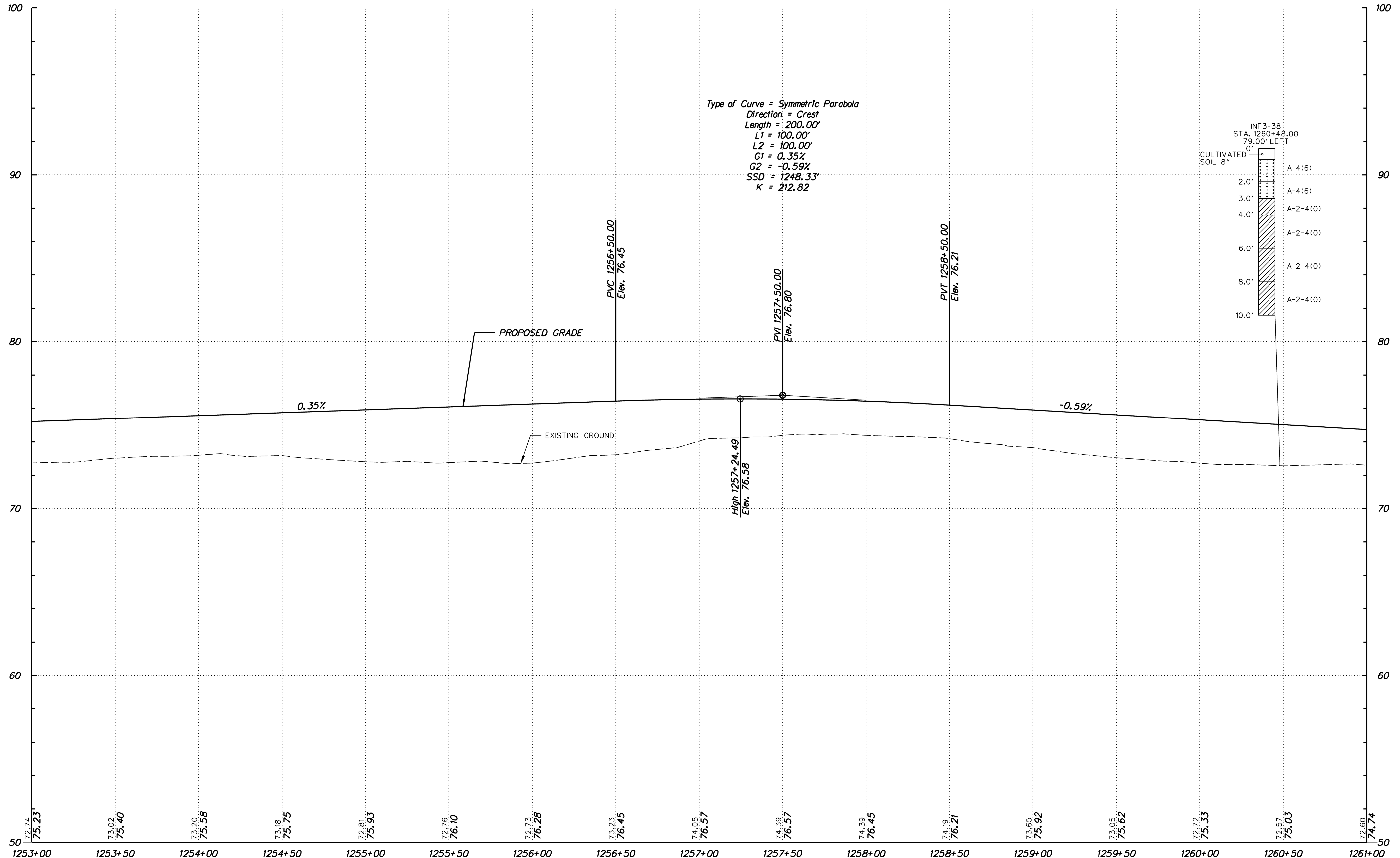

Type of Curve = Symmetric Parabola
 Direction = Crest
 Length = 200.00'
 L1 = 100.00'
 L2 = 100.00'
 G1 = 0.35%
 G2 = -0.59%
 SSD = 1248.33'
 K = 212.82

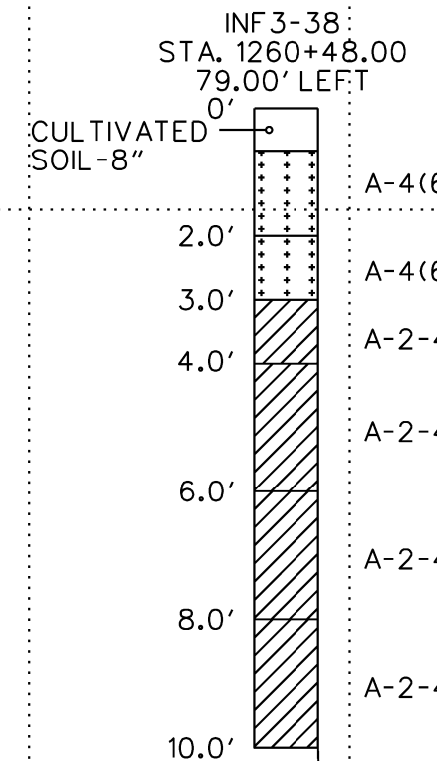

1253+00	72.74	75.23	1253+50	73.02	75.40	1254+00	73.20	75.58	1254+50	73.18	75.75	1255+00	72.81	75.93	1255+50	72.76	76.10	1256+00	72.73	76.28	1256+50	73.23	76.45	1257+00	74.05	76.57	1257+50	74.39	76.57	1258+00	74.39	76.45	1258+50	74.19	76.21	1259+00	73.65	75.92	1259+50	73.05	75.62	1260+00	72.72	75.33	1260+50	72.57	75.03	1261+00	72.60	74.74
---------	-------	-------	---------	-------	-------	---------	-------	-------	---------	-------	-------	---------	-------	-------	---------	-------	-------	---------	-------	-------	---------	-------	-------	---------	-------	-------	---------	-------	-------	---------	-------	-------	---------	-------	-------	---------	-------	-------	---------	-------	-------	---------	-------	-------	---------	-------	-------	---------	-------	-------

WARWICK ROAD

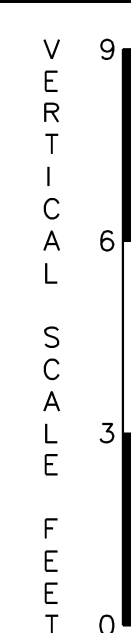

ADDENDUMS / REVISIONS	

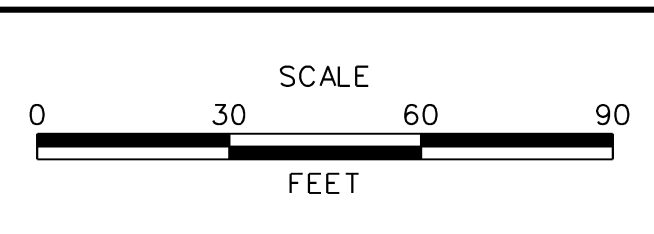

US 301
 MARYLAND STATE LINE
 TO LEVELS ROAD

CONTRACT	BRIDGE NO.
T200811301	
COUNTY	DESIGNED BY: MFM
NEW CASTLE	CHECKED BY: SKH

PROFILES

PF-46	SHEET NO.
	149
	TOTAL SHTS.
	850

J:\2008 PROJECTS\334801\700ADD\750AET\ROADWAY\PF_30\AET_047.DGN

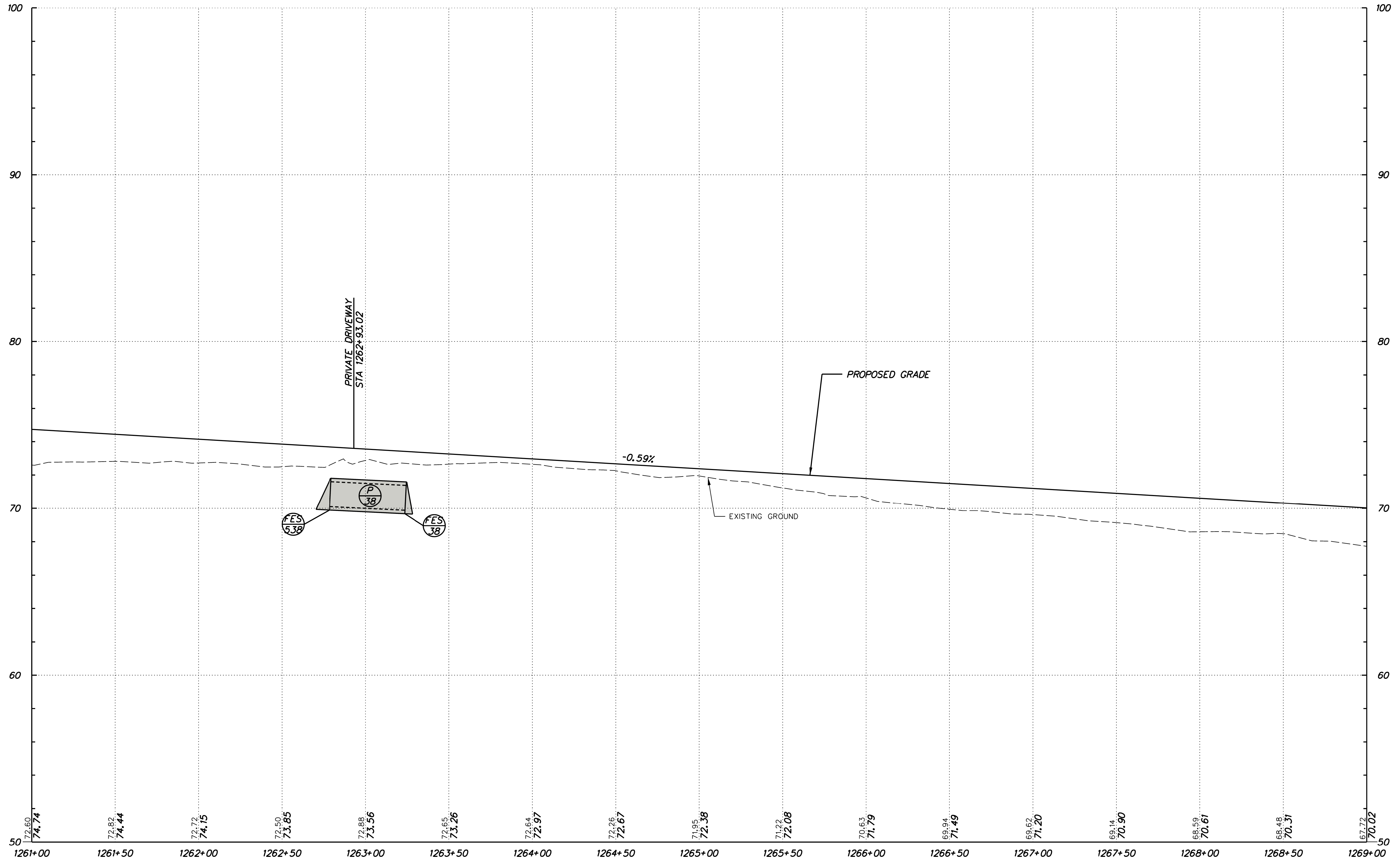

WARWICK ROAD

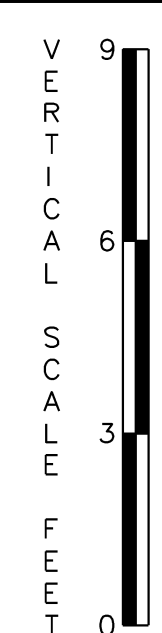

PF-47



ADDENDUMS / REVISIONS	

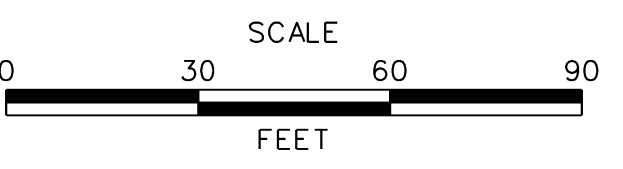

US 301
MARYLAND STATE LINE
TO LEVELS ROAD

CONTRACT	BRIDGE NO.
T200811301	
COUNTY	DESIGNED BY: MFM
NEW CASTLE	CHECKED BY: SKH

PROFILES

SHEET NO.
150
TOTAL SHTS.
850

J:\2008 PROJECTS\334801\700ADD\750AET\ROADWAY\PF_30\AET_048.DGN

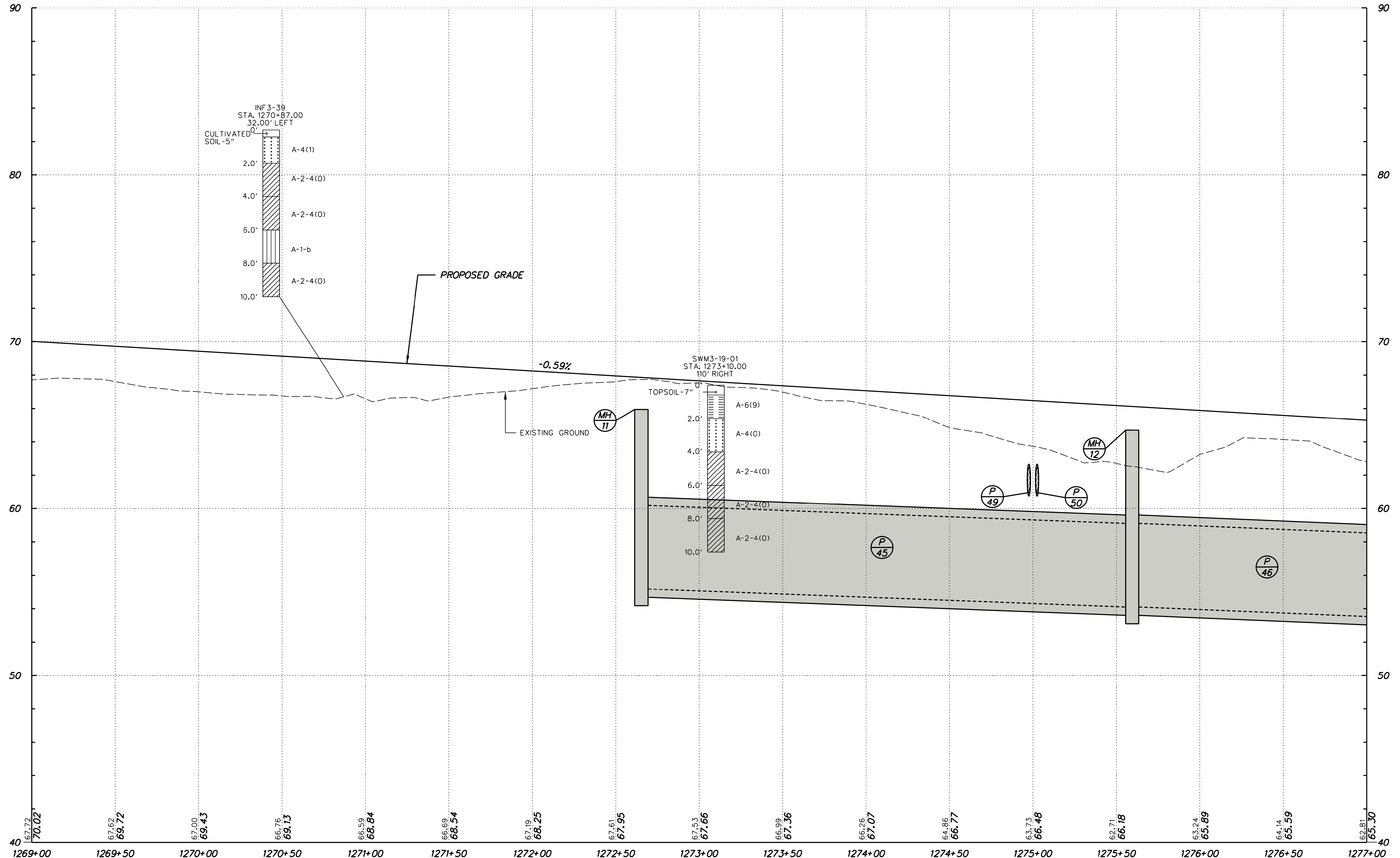

WARWICK ROAD

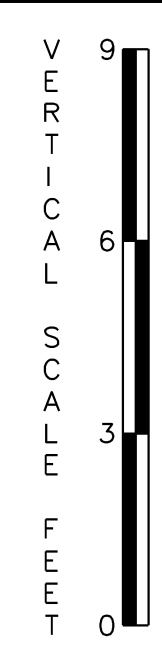

PF-48



ADDENDUMS / REVISIONS	

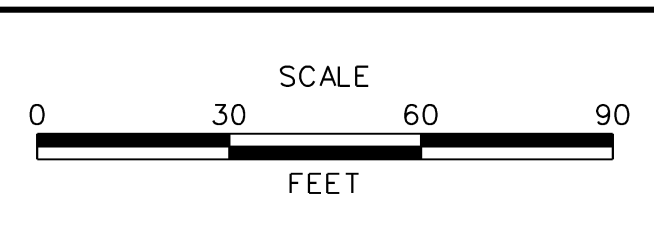

US 301
MARYLAND STATE LINE
TO LEVELS ROAD

CONTRACT	BRIDGE NO.
T200811301	
COUNTY	DESIGNED BY: MFM
NEW CASTLE	CHECKED BY: SKH

PROFILES	SHEET NO.
	151
	TOTAL SHTS.
	850

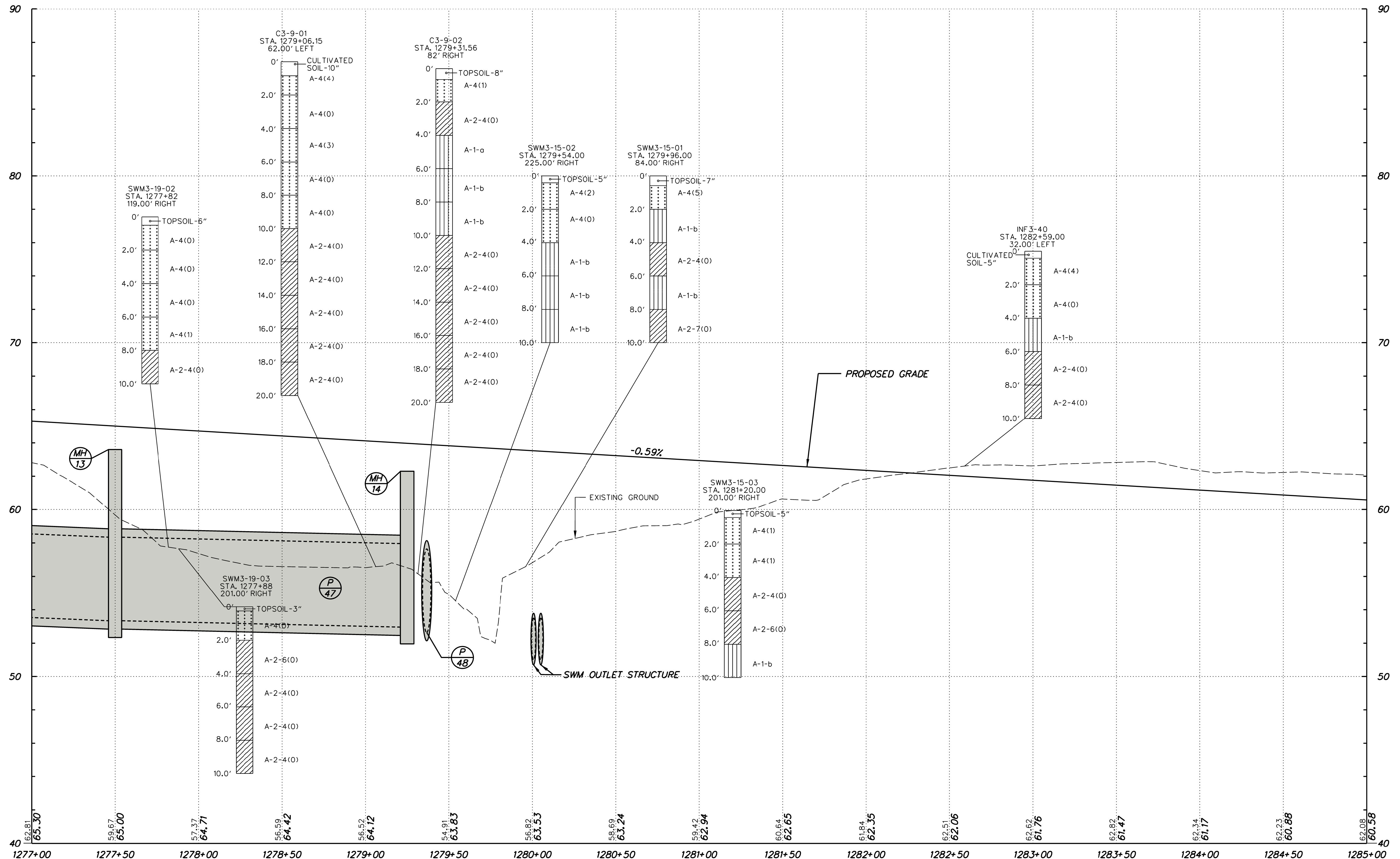

1277+00 1277+50 1278+00 1278+50 1279+00 1279+50 1280+00 1280+50 1281+00 1281+50 1282+00 1282+50 1283+00 1283+50 1284+00 1284+50 1285+00

WARWICK ROAD

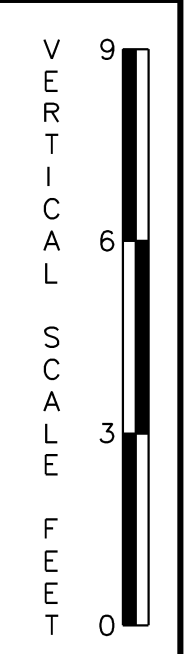

J:\2008 PROJECTS\334801\700ADD\750AET\ROADWAY\PF_30\AET_049.DGN



ADDENDUMS / REVISIONS	

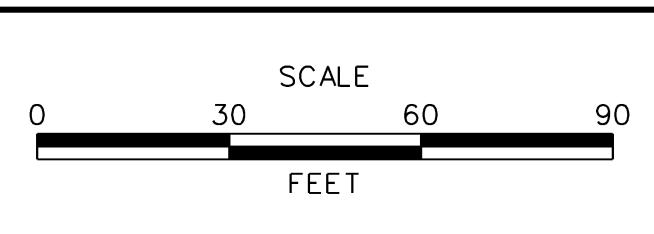

US 301
MARYLAND STATE LINE
TO LEVELS ROAD

CONTRACT	BRIDGE NO.
T200811301	
COUNTY	DESIGNED BY: MFM
NEW CASTLE	CHECKED BY: SKH

PROFILES	SHEET NO.
	TOTAL SHTS.
	850

PF-49

J:\2008 PROJECTS\34801\700ADD\750AET\ROADWAY\PF_30\AET_050.DGN

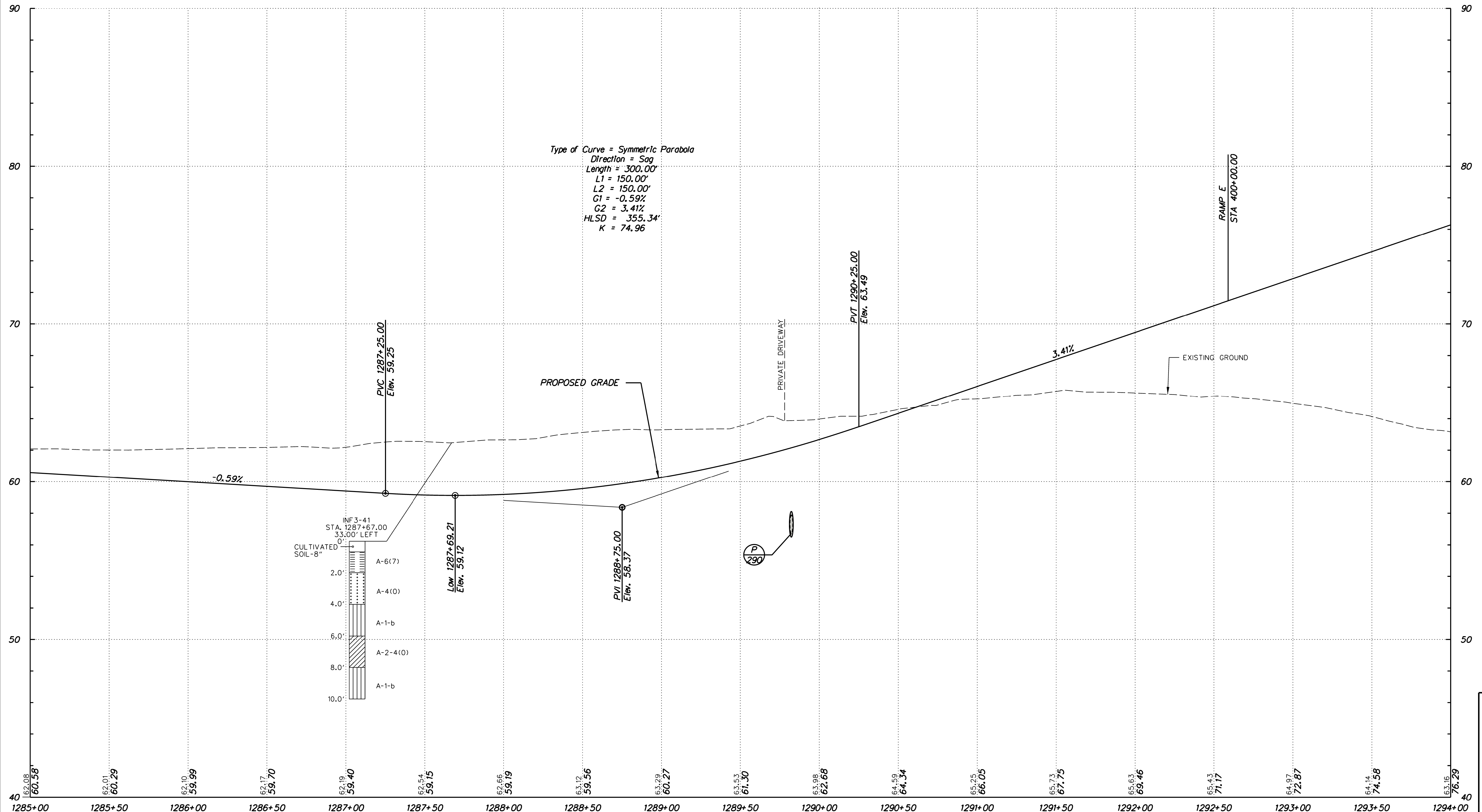

WARWICK ROAD AND LEVELS ROAD

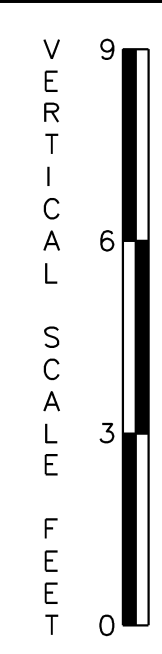

ADDENDUMS / REVISIONS	

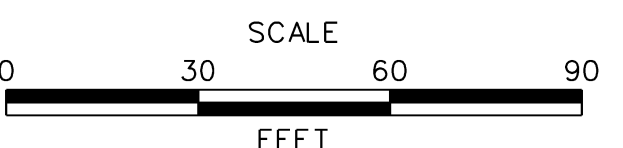

US 301
 MARYLAND STATE LINE
 TO LEVELS ROAD

CONTRACT	BRIDGE NO.
T200811301	
COUNTY	DESIGNED BY: MFM
NEW CASTLE	CHECKED BY: SKH

PROFILES

PF-50
SHEET NO.
153
TOTAL SHTS.
850

J:\2008 PROJECTS\34801\700ADD\750AET\ROADWAY\PF_301AET_051.DGN

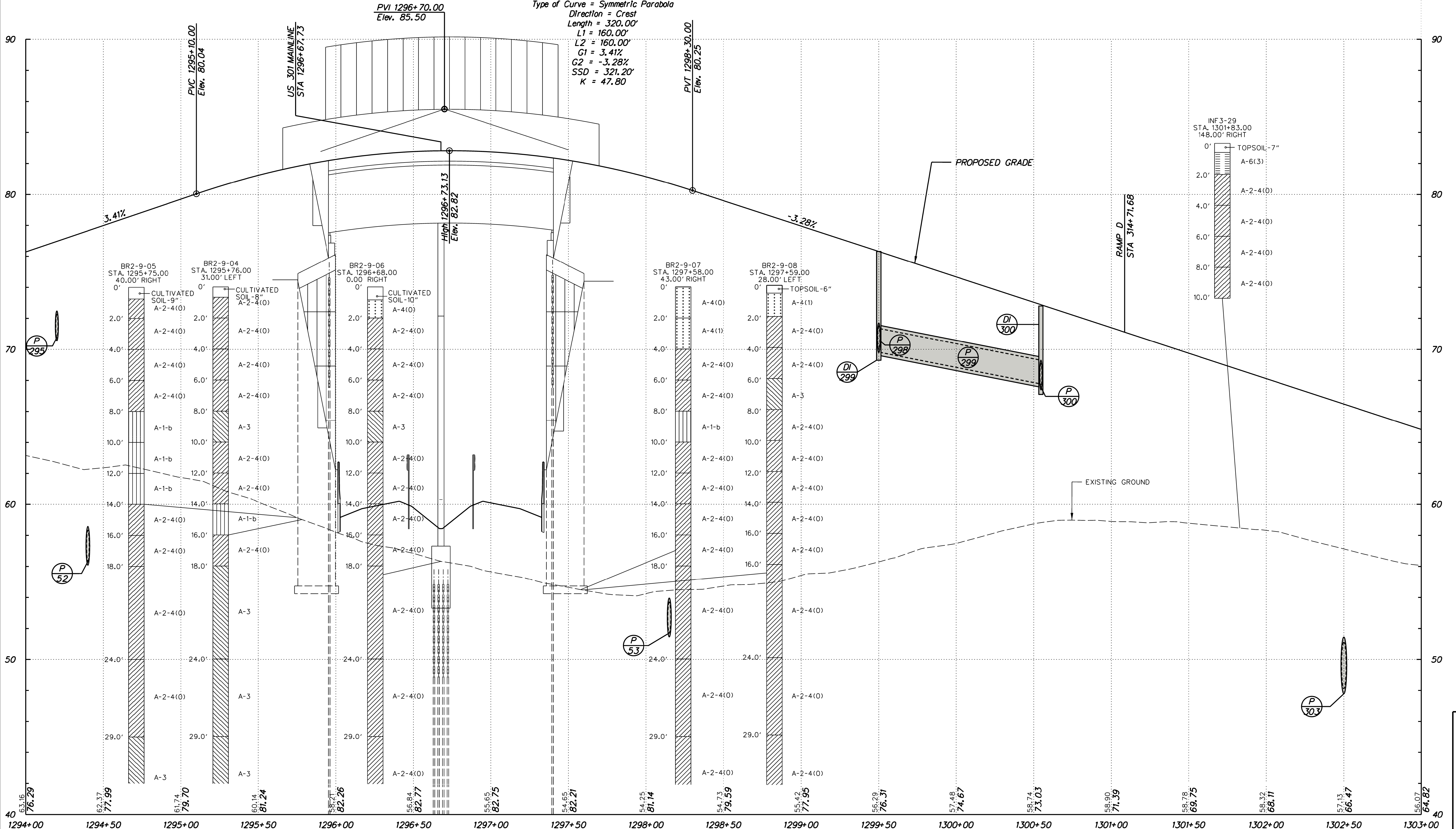

Type of Curve = Symmetric Parabola
 Direction = Crest
 Length = 320.00'
 L1 = 160.00'
 L2 = 160.00'
 G1 = 3.41%
 G2 = -3.28%
 SSD = 321.20'
 K = 47.80

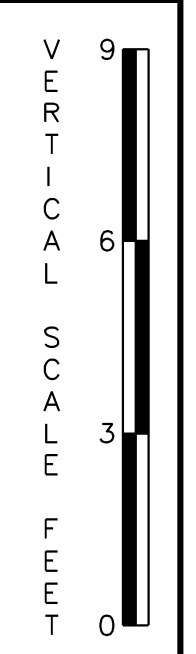
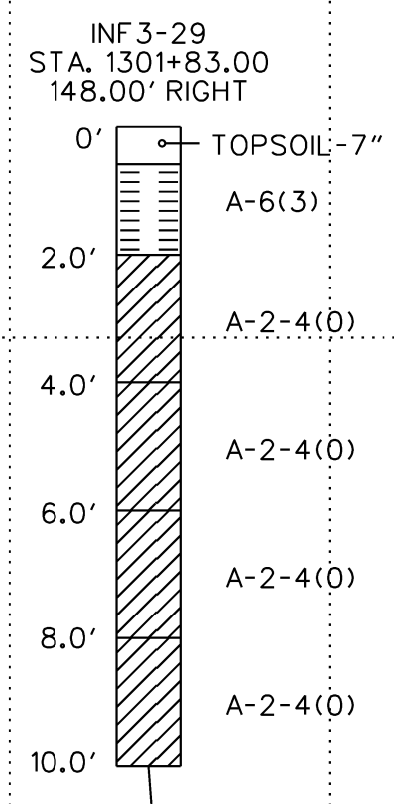

LEVELS ROAD



ADDENDUMS / REVISIONS	

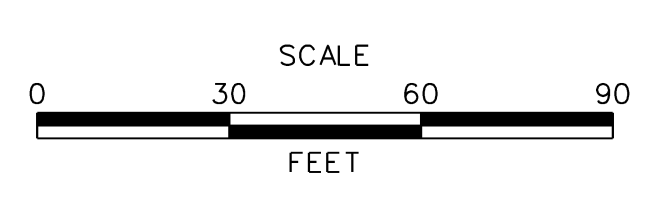

US 301
 MARYLAND STATE LINE
 TO LEVELS ROAD

CONTRACT T200811301	BRIDGE NO.
COUNTY NEW CASTLE	DESIGNED BY: MFM
	CHECKED BY: SKH

PROFILES

PF-51	SHEET NO. 154
	TOTAL SHTS. 850

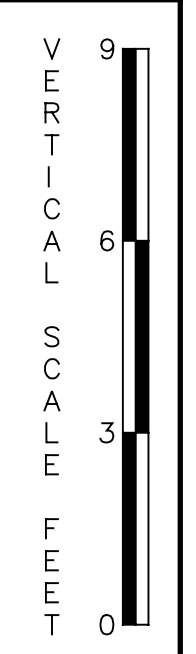
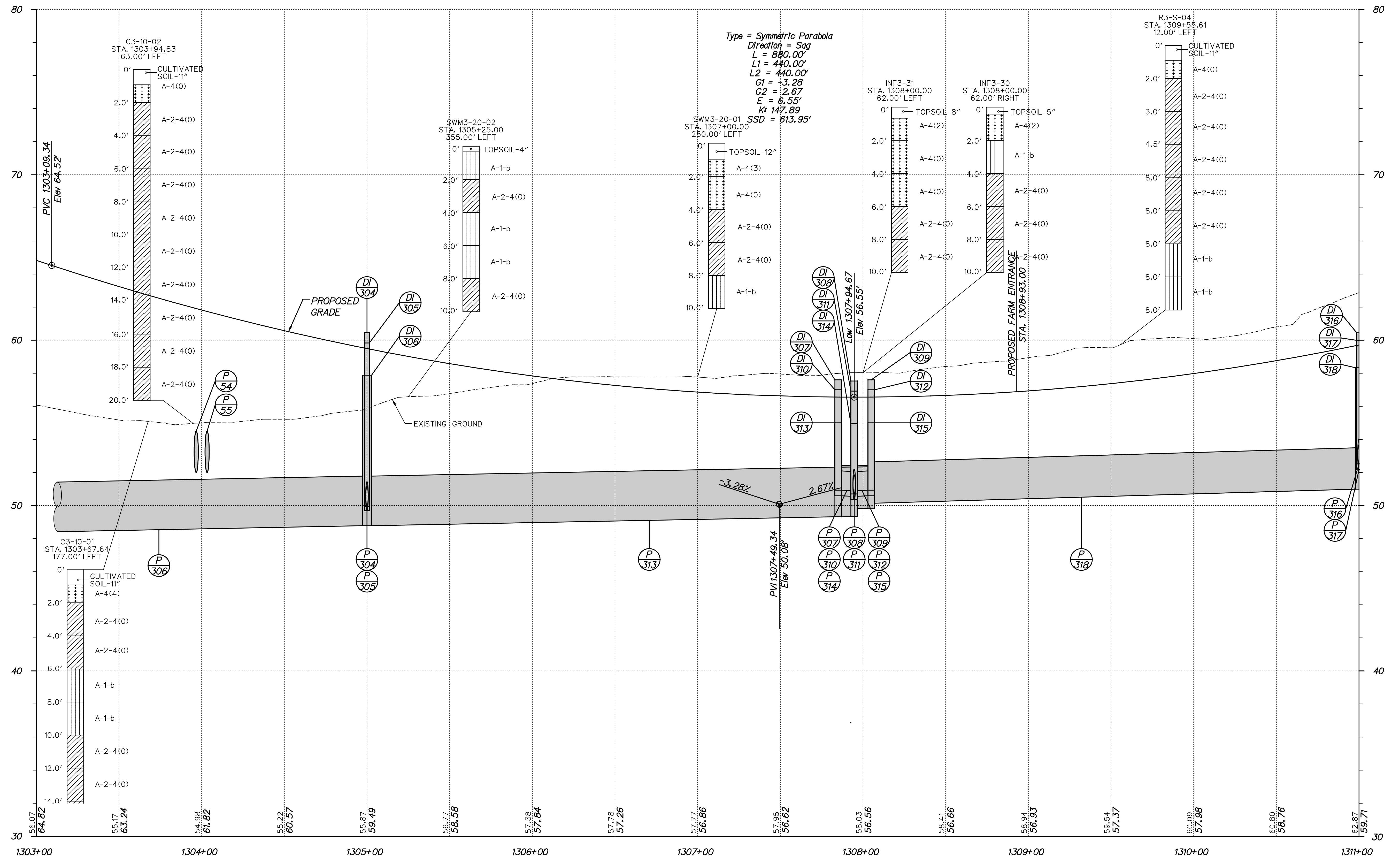

PF-52



ADDENDUMS / REVISIONS	

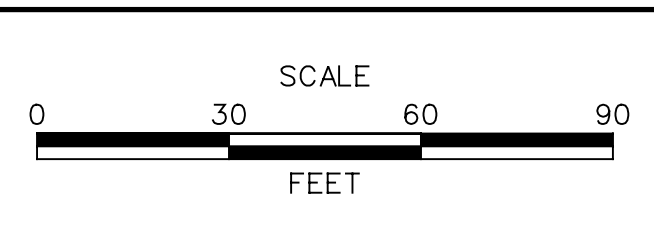

US 301
 MARYLAND STATE LINE
 TO LEVELS ROAD

CONTRACT T200811301	BRIDGE NO.
COUNTY NEW CASTLE	DESIGNED BY: MAG/TAM
	CHECKED BY: PAH

PROFILES	TOTAL SHTS.
	155
	850

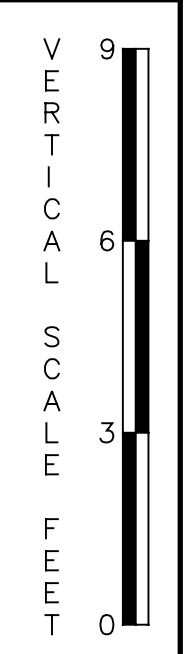
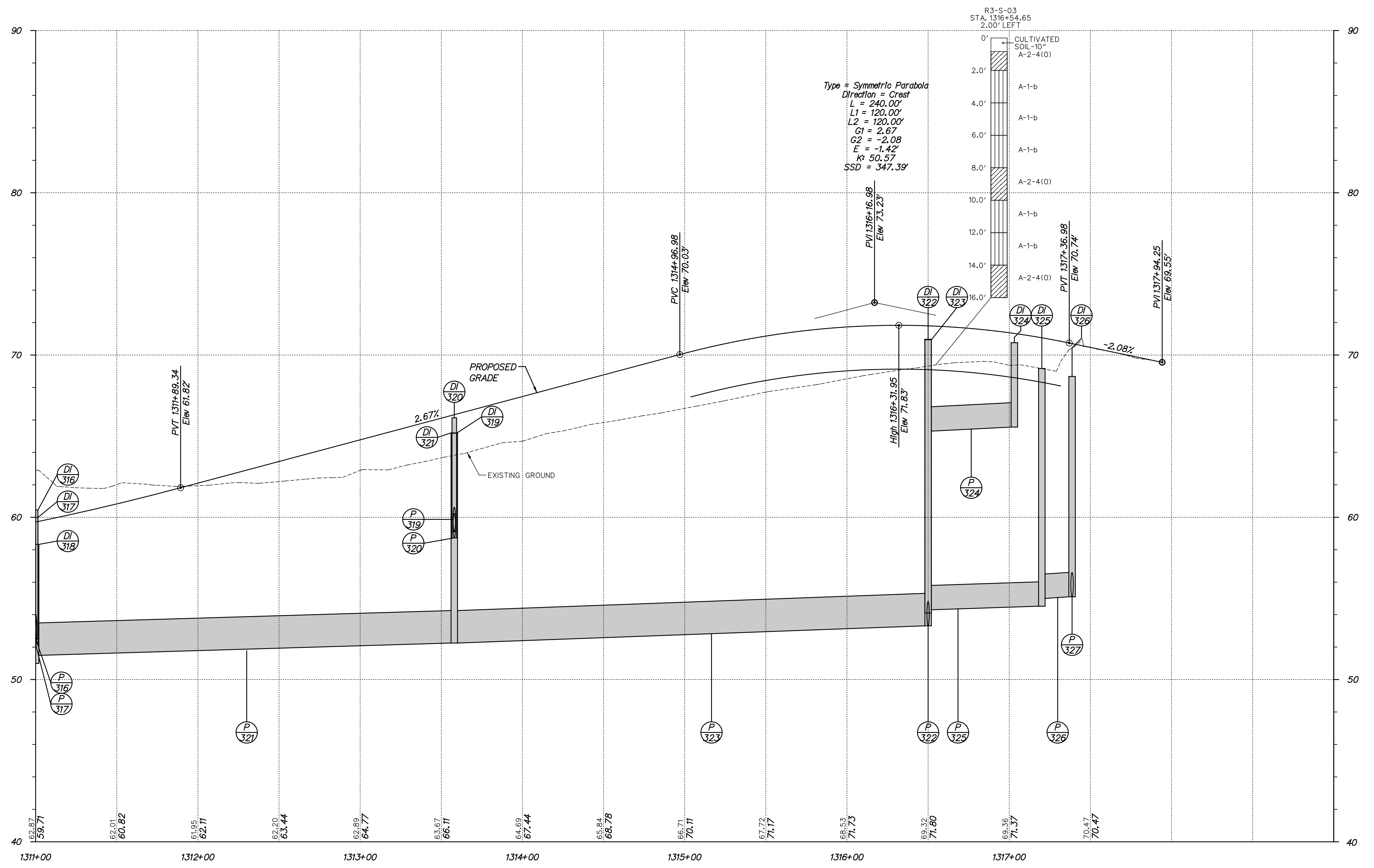

ADDENDUMS / REVISIONS	

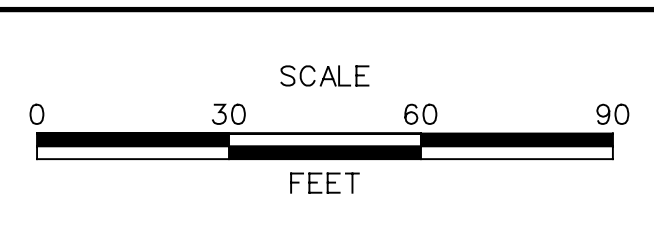

CONTRACT T200811301	BRIDGE NO.
COUNTY NEW CASTLE	DESIGNED BY: MAG/TAM
	CHECKED BY: PAH

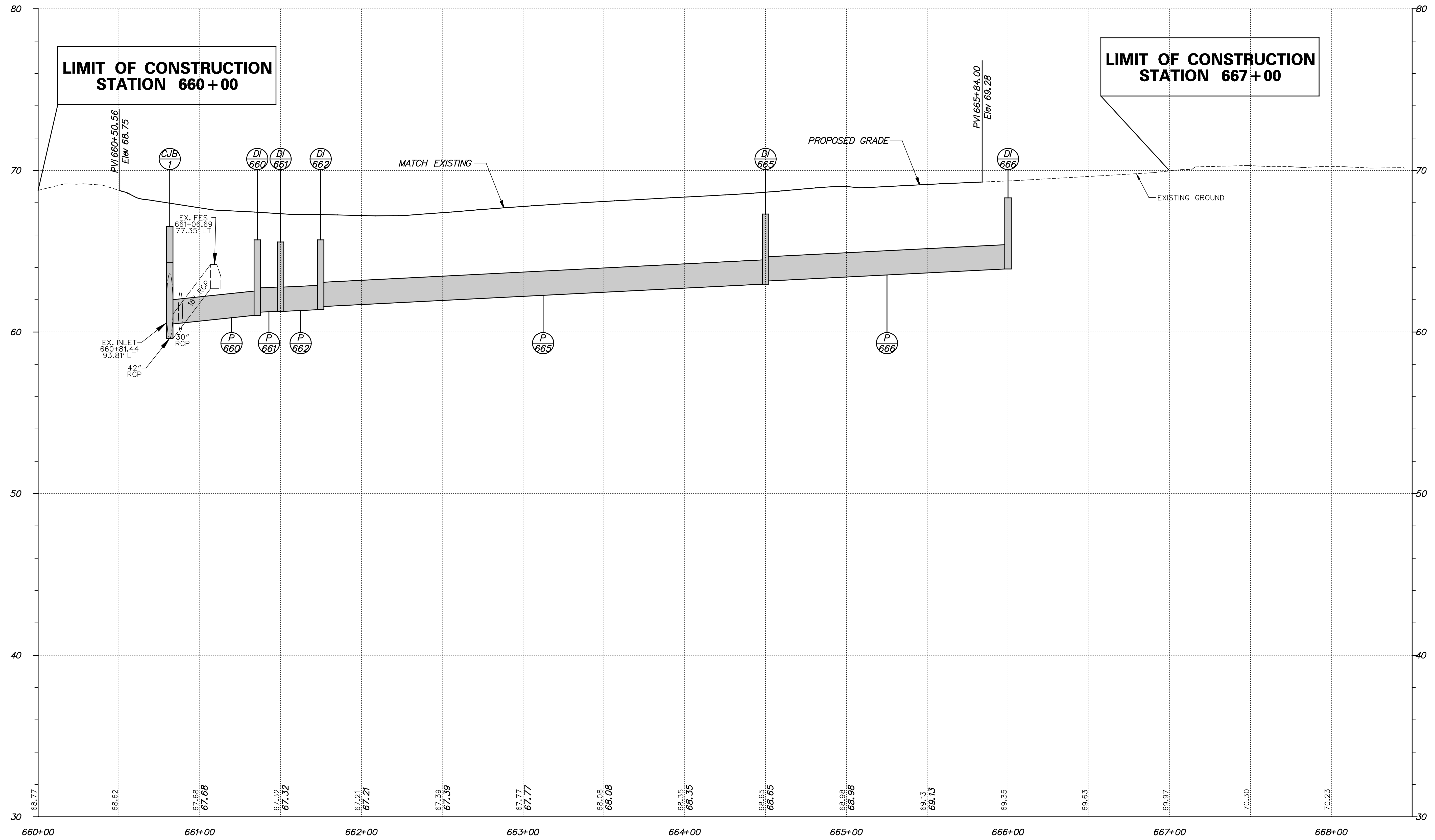

EXISTING LEVELS ROAD

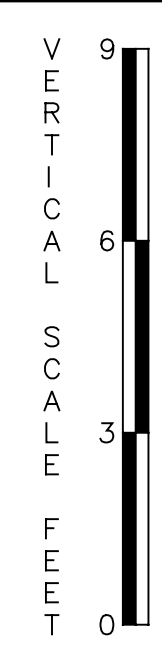

PF-54

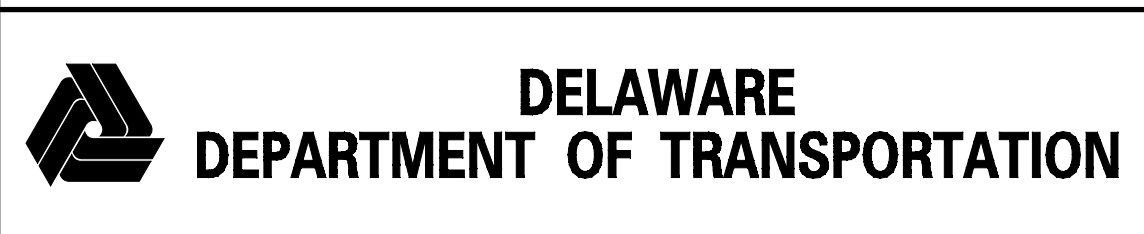

ADDENDUMS / REVISIONS	

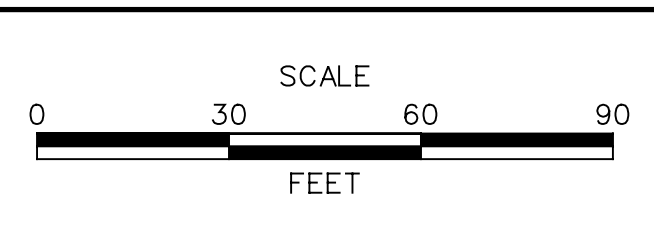

US 301 MARYLAND STATE LINE TO LEVELS ROAD

CONTRACT T200811301	BRIDGE NO.
COUNTY NEW CASTLE	DESIGNED BY: MAG/TAM
	CHECKED BY: PAH

PROFILES

SHEET NO. 157
TOTAL SHTS. 850

J:\2008 PROJECTS\3X34801\700CADD\750AET\ROADWAY\PF_301AET_065.DGN

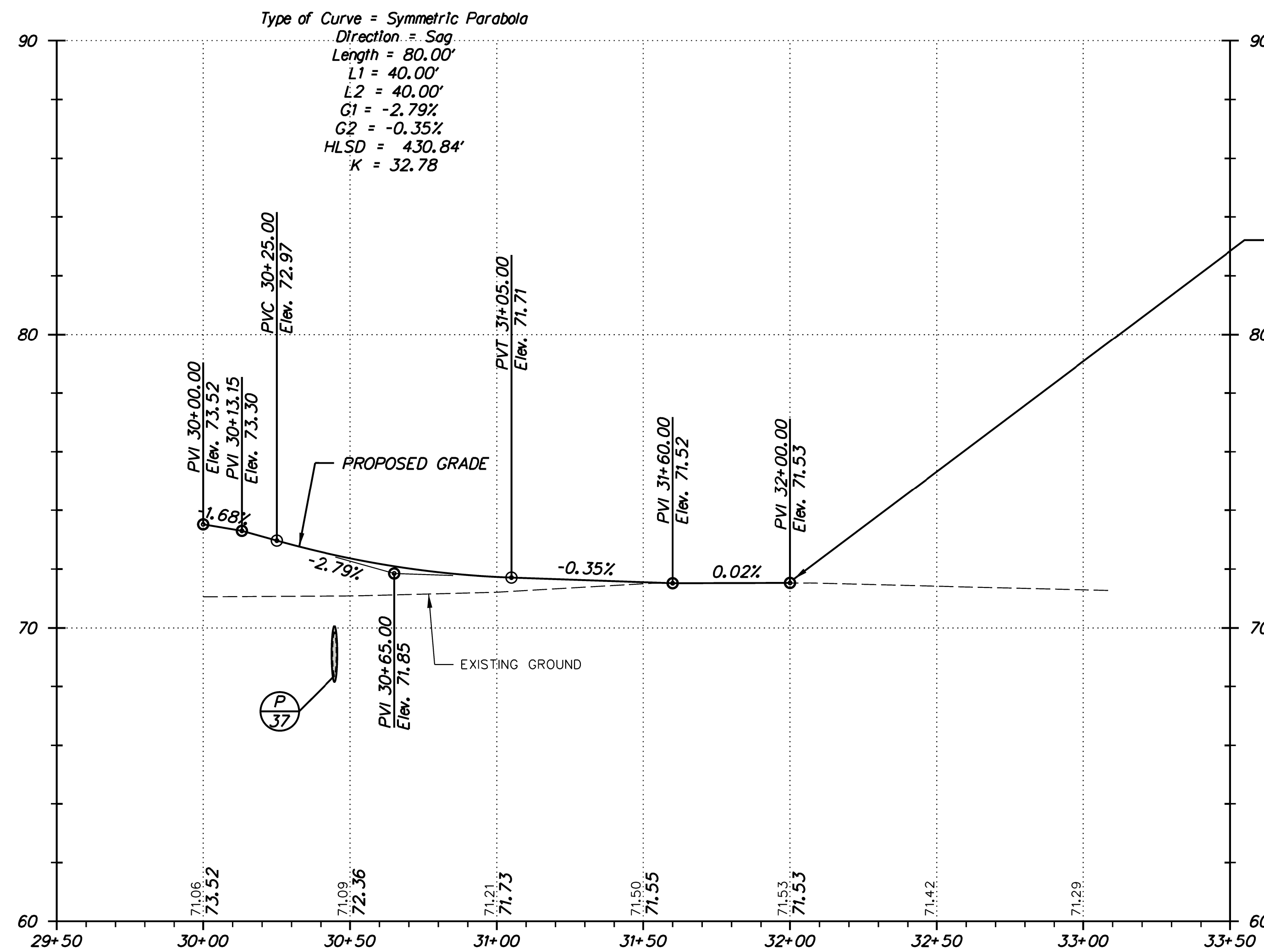

LIMIT OF CONSTRUCTION
CONTRACT T200811301
STATION 32+00

MIDDLENECK ROAD

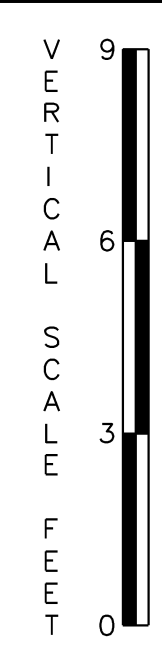

PF-55



ADDENDUMS / REVISIONS	

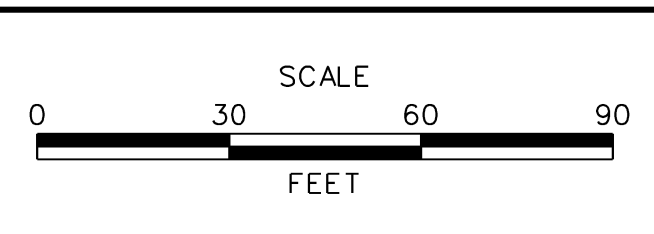

US 301
MARYLAND STATE LINE
TO LEVELS ROAD

CONTRACT	BRIDGE NO.
T200811301	
COUNTY	DESIGNED BY: MFM
NEW CASTLE	CHECKED BY: SKH

PROFILES

SHEET NO.
158
TOTAL SHTS.
850

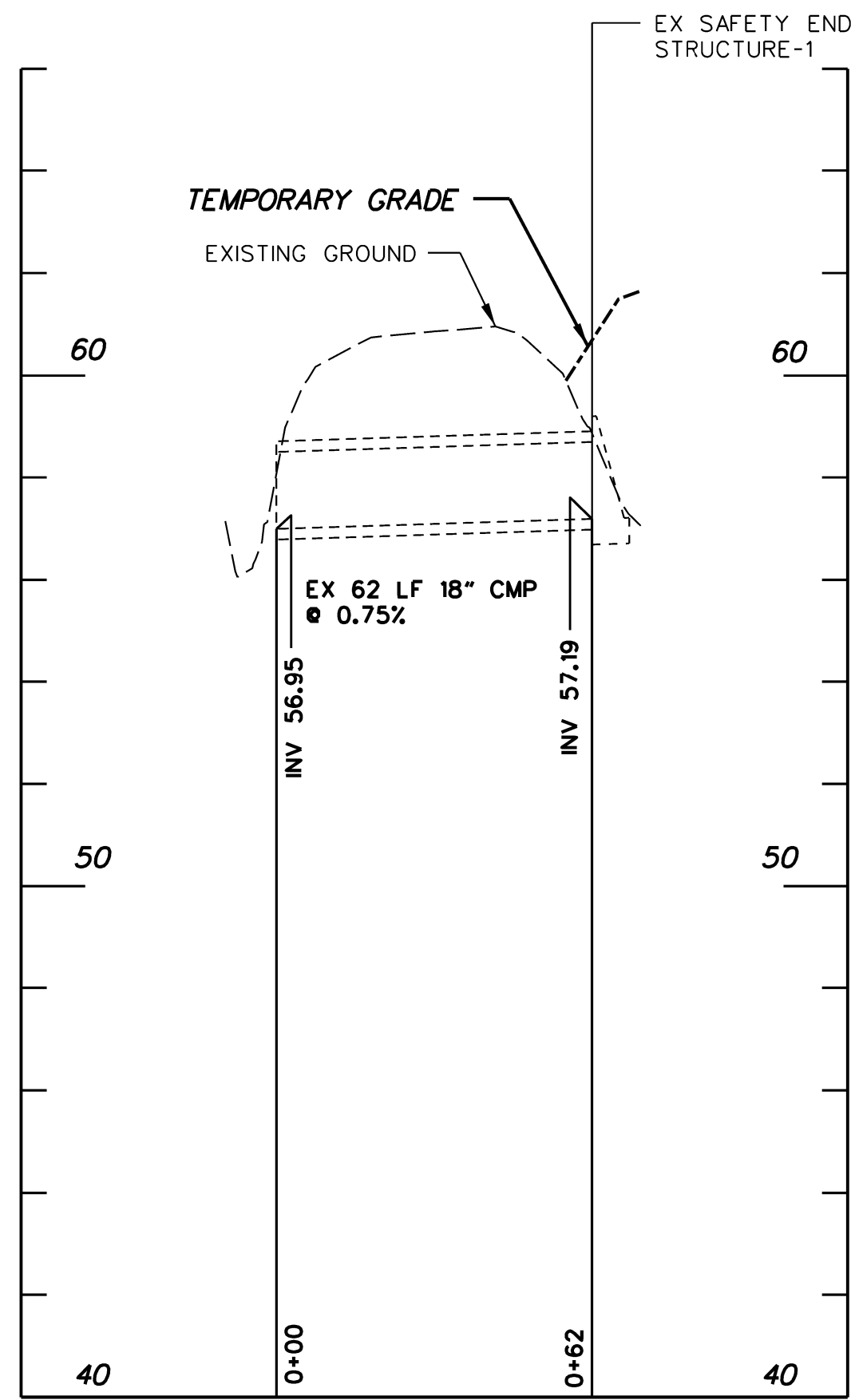

STA 97+50 SOUTHBOUND

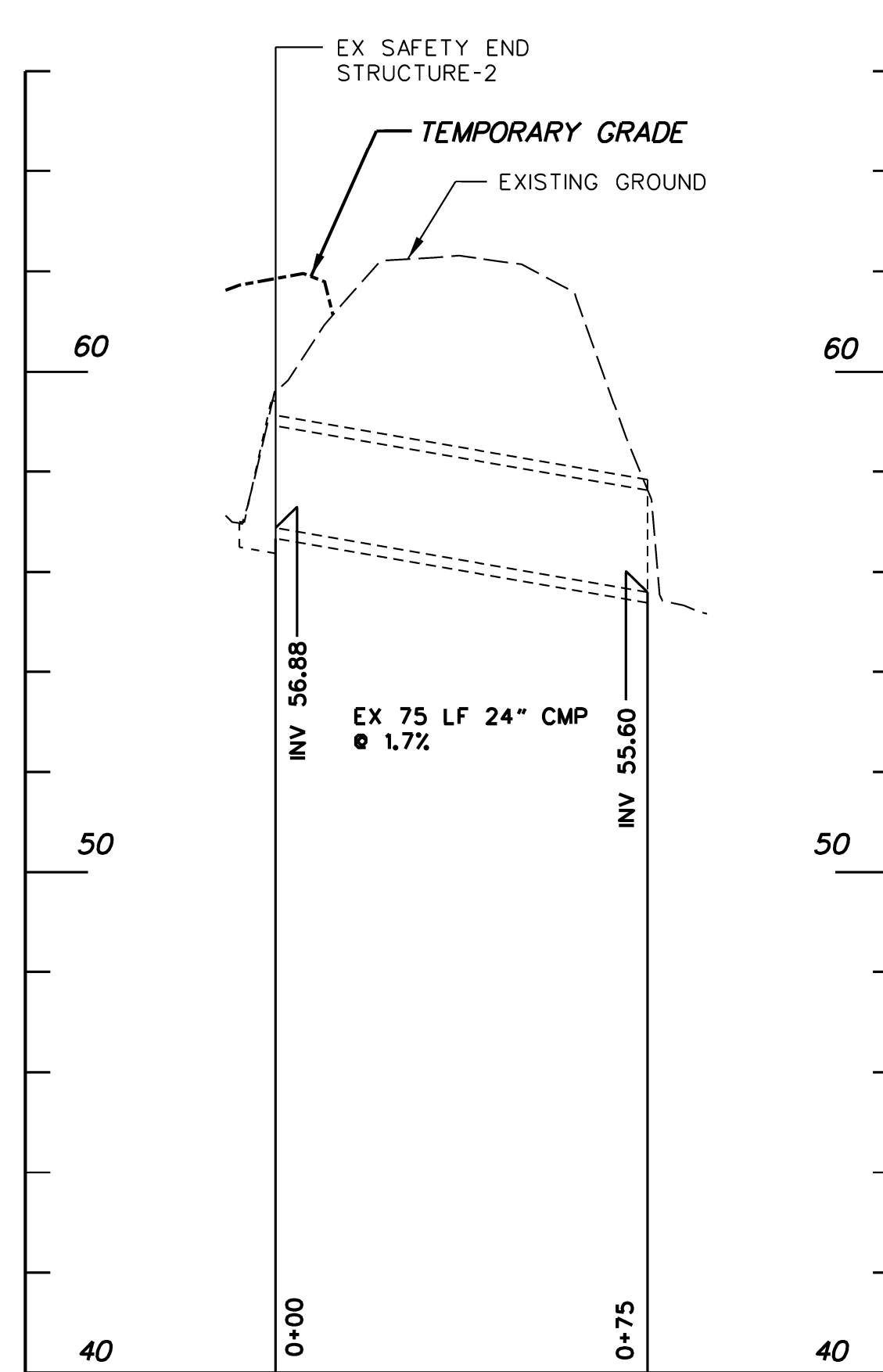

STA 97+50 NORTHBOUND

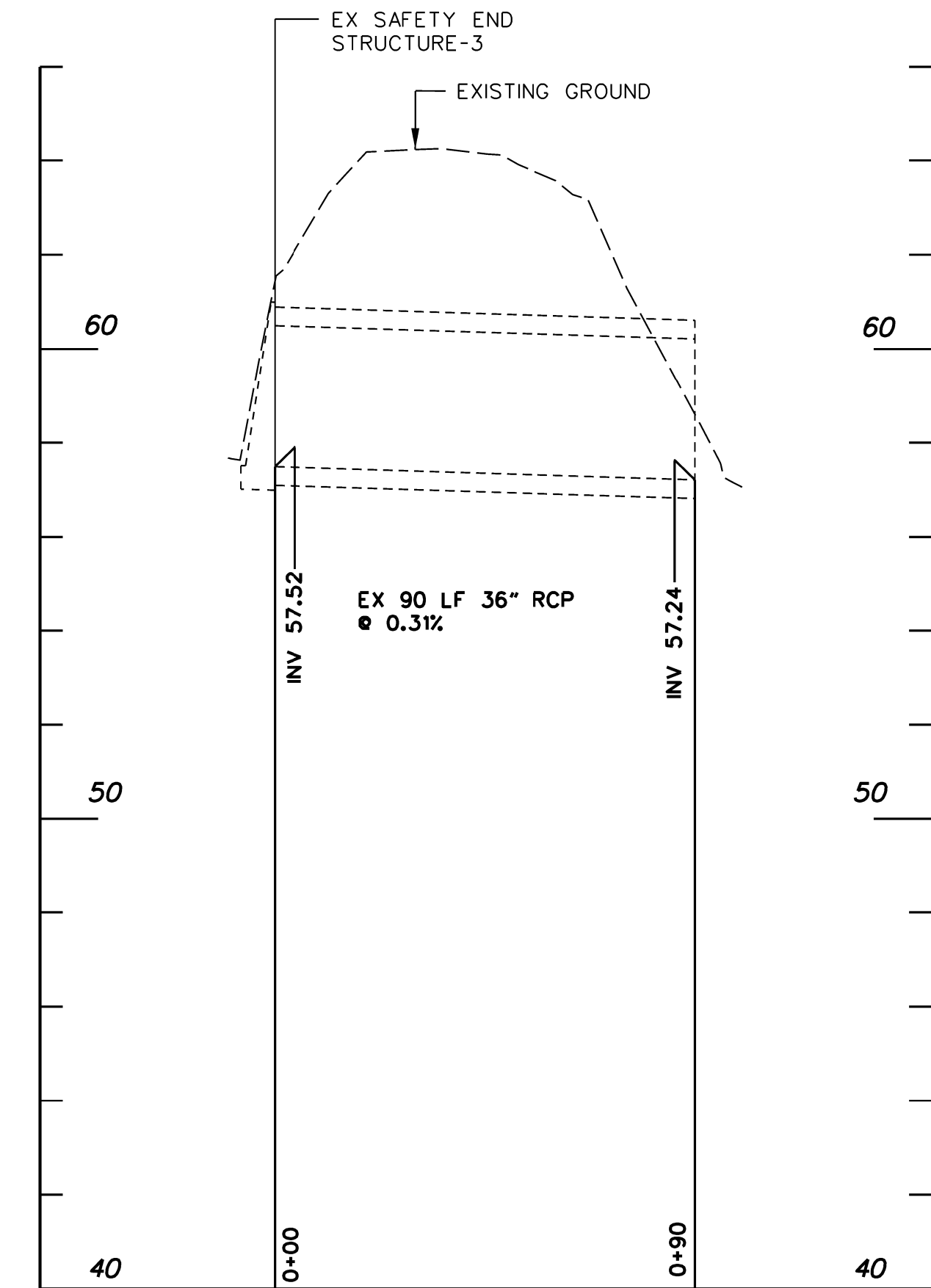

STA 103+25 NORTHBOUND

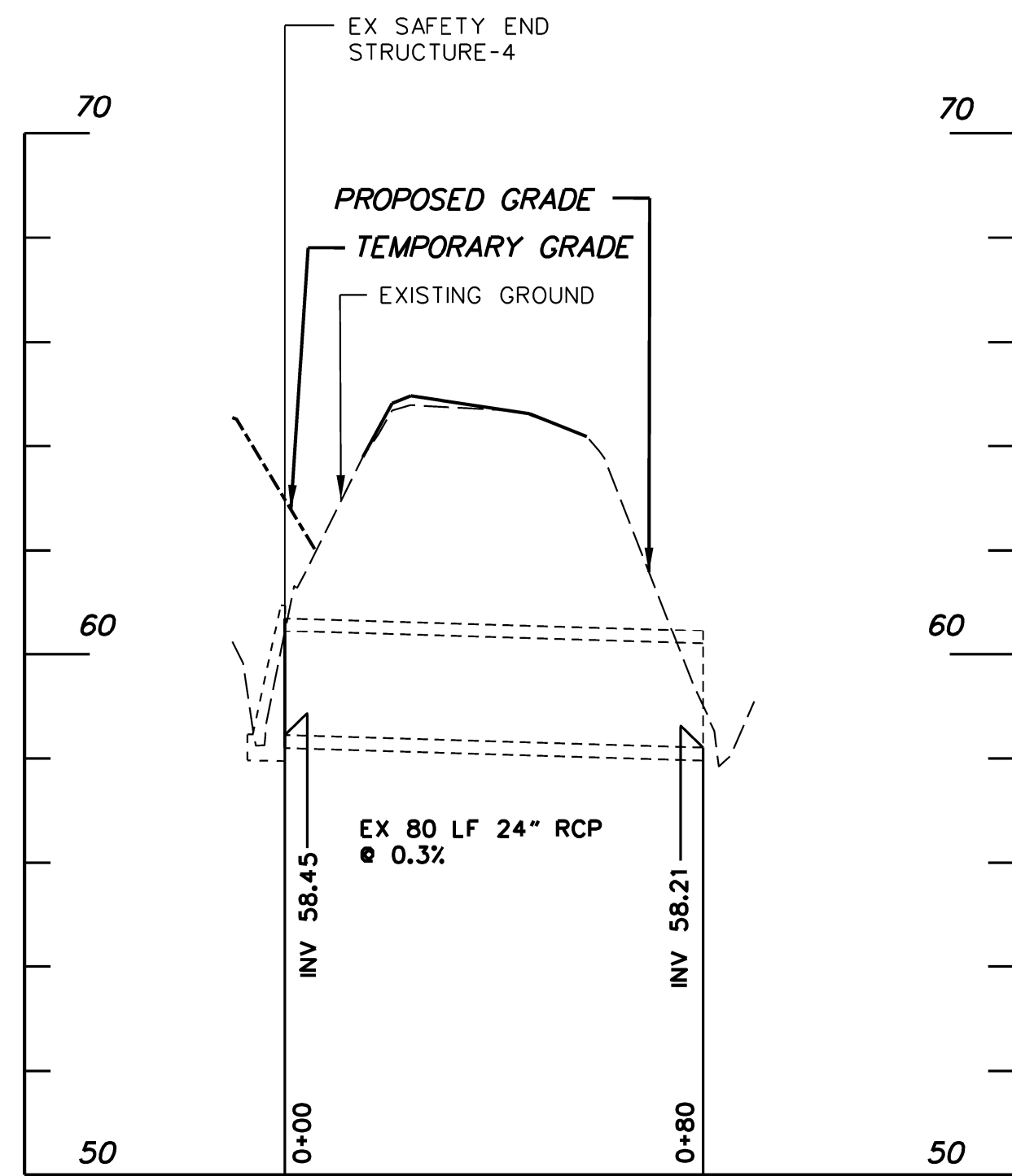

STA 104+55 NORTHBOUND

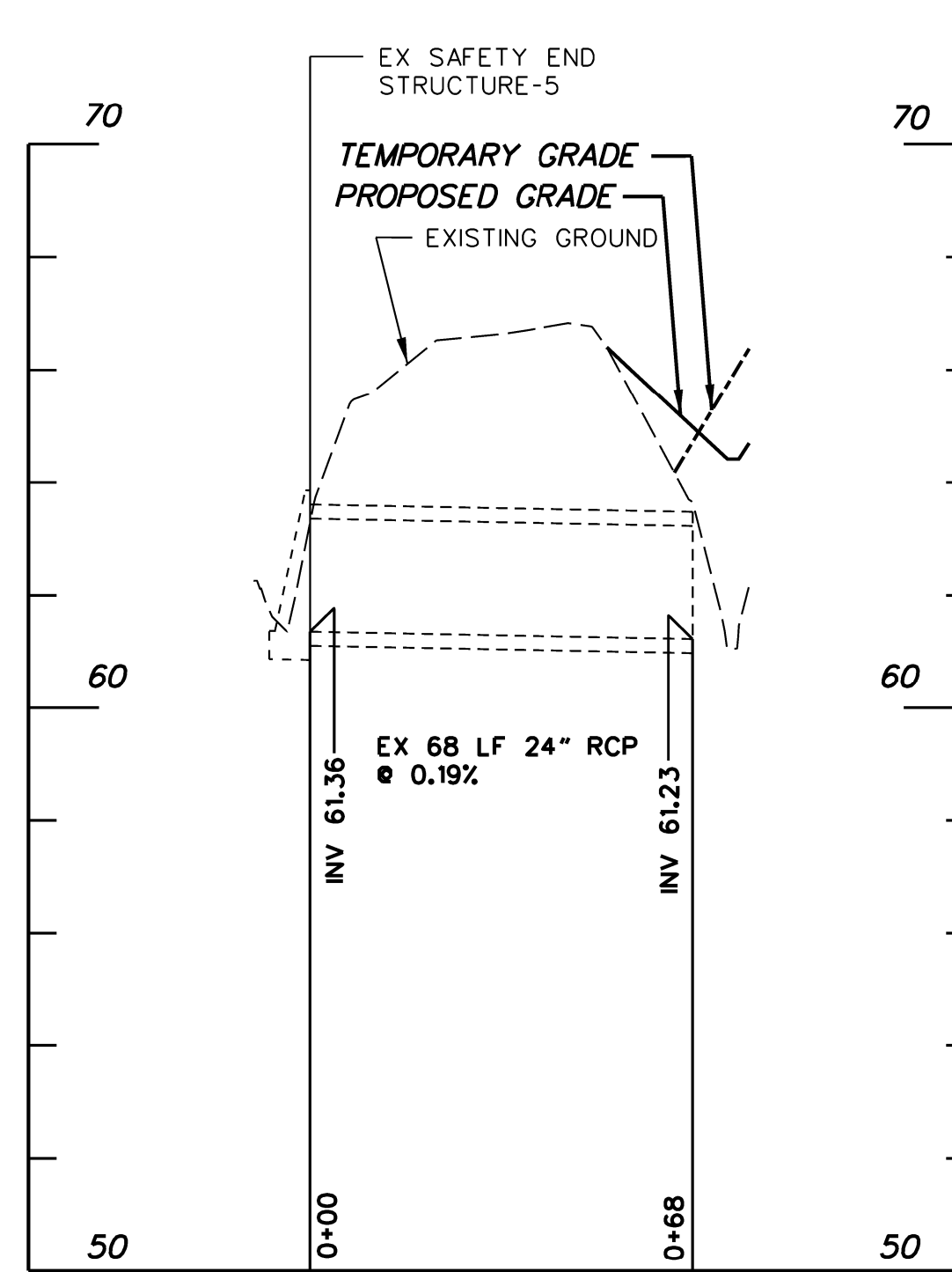

STA 108+58 SOUTHBOUND

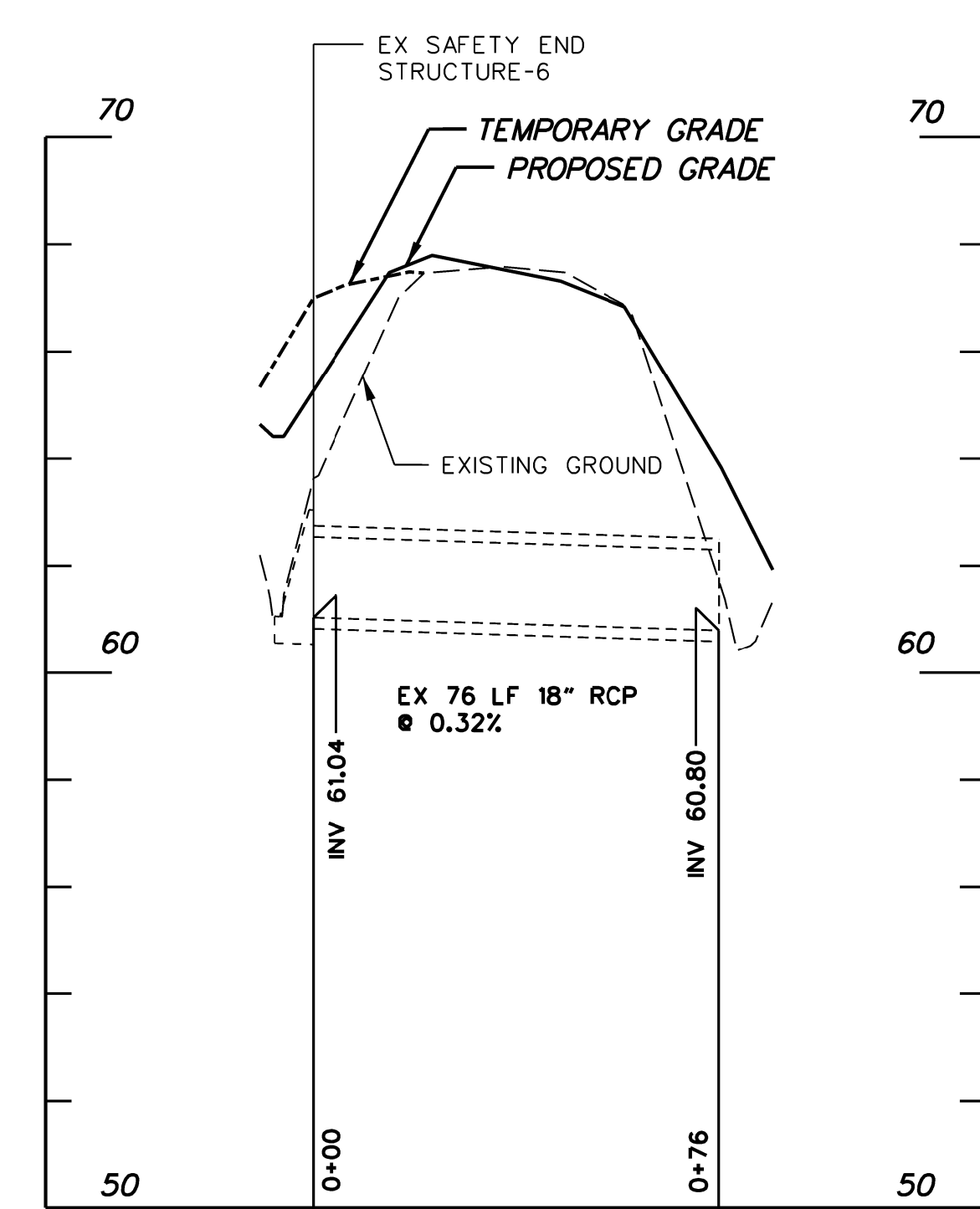

STA 108+58 NORTHBOUND

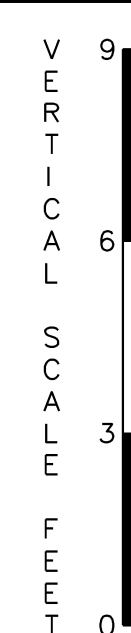

J:\2008 PROJECTS\34801\700CADD\750AET\ROADWAY\PF MD_301D53_001.DGN



ADDENDUMS / REVISIONS	

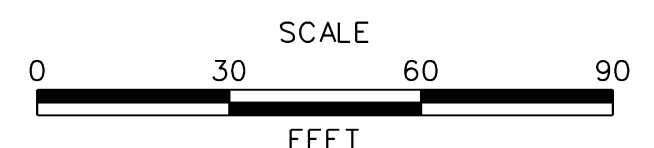

US 301
MARYLAND STATE LINE
TO LEVELS ROAD

CONTRACT T200811301	BRIDGE NO.
COUNTY CECIL	DESIGNED BY: DJJ
	CHECKED BY: TC

MARYLAND
DRAINAGE PROFILES

PF-56	SHEET NO. 159
	TOTAL SHTS. 850

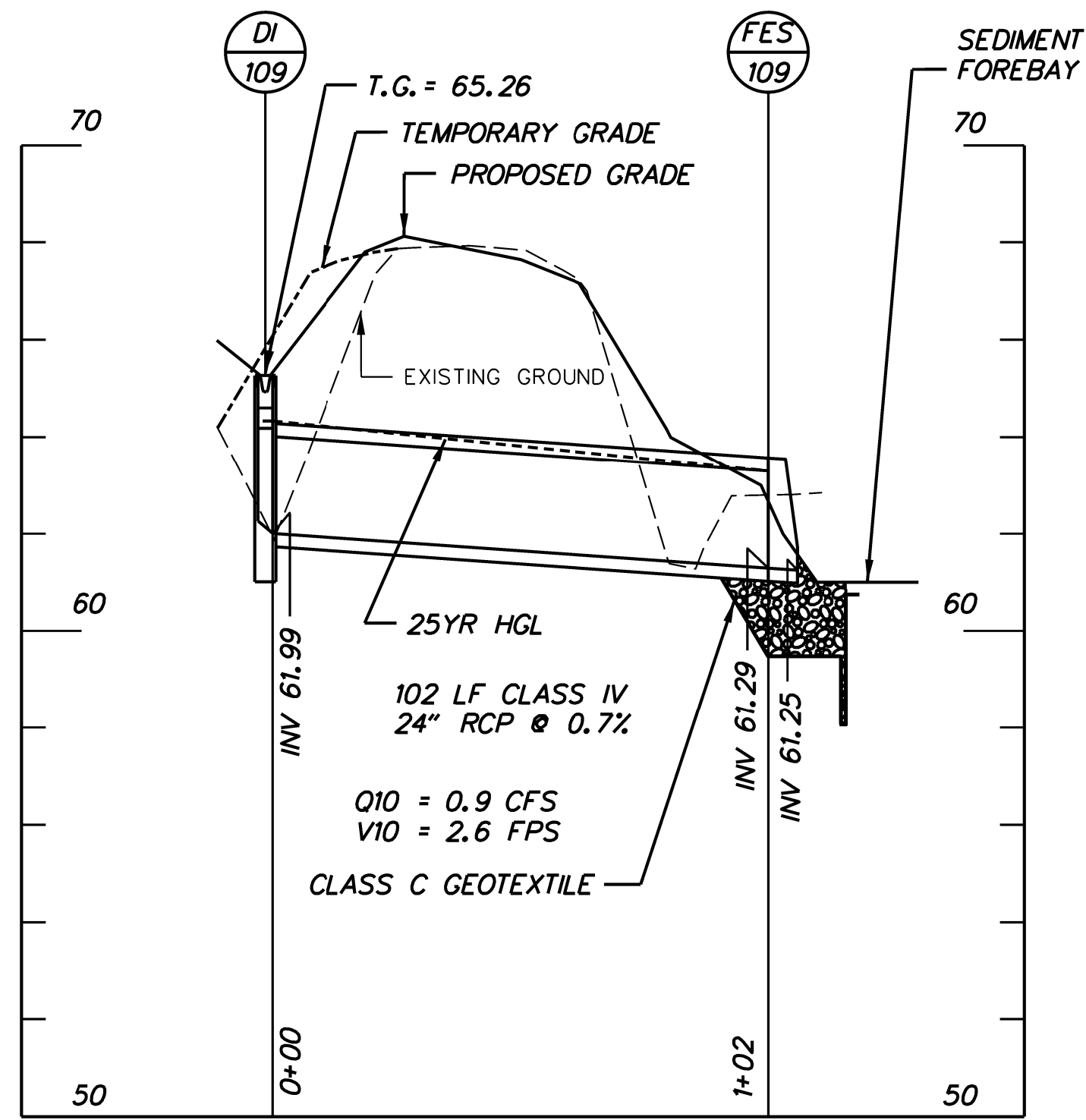

DI-109 TO FES-109

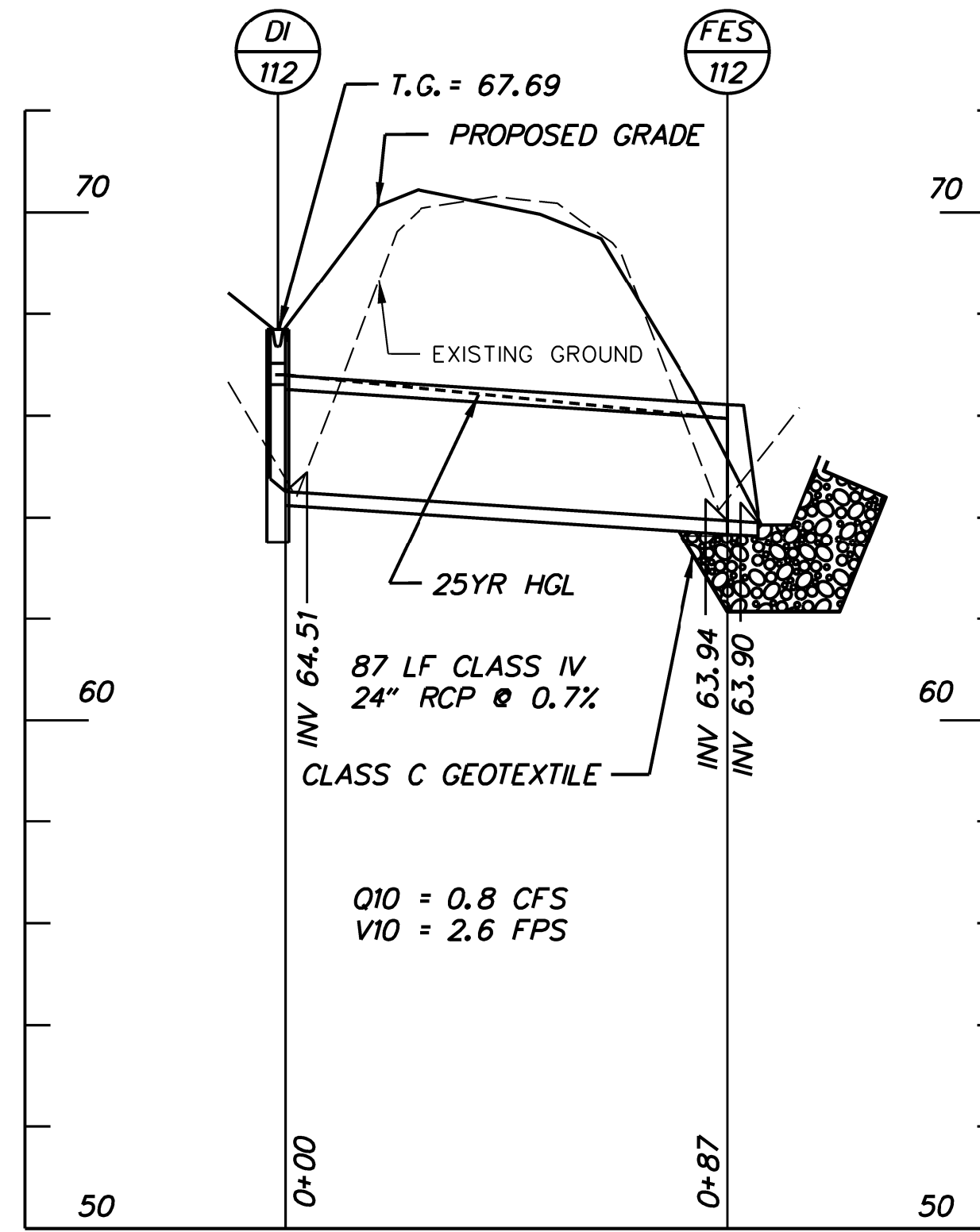

DI-112 TO FES-112

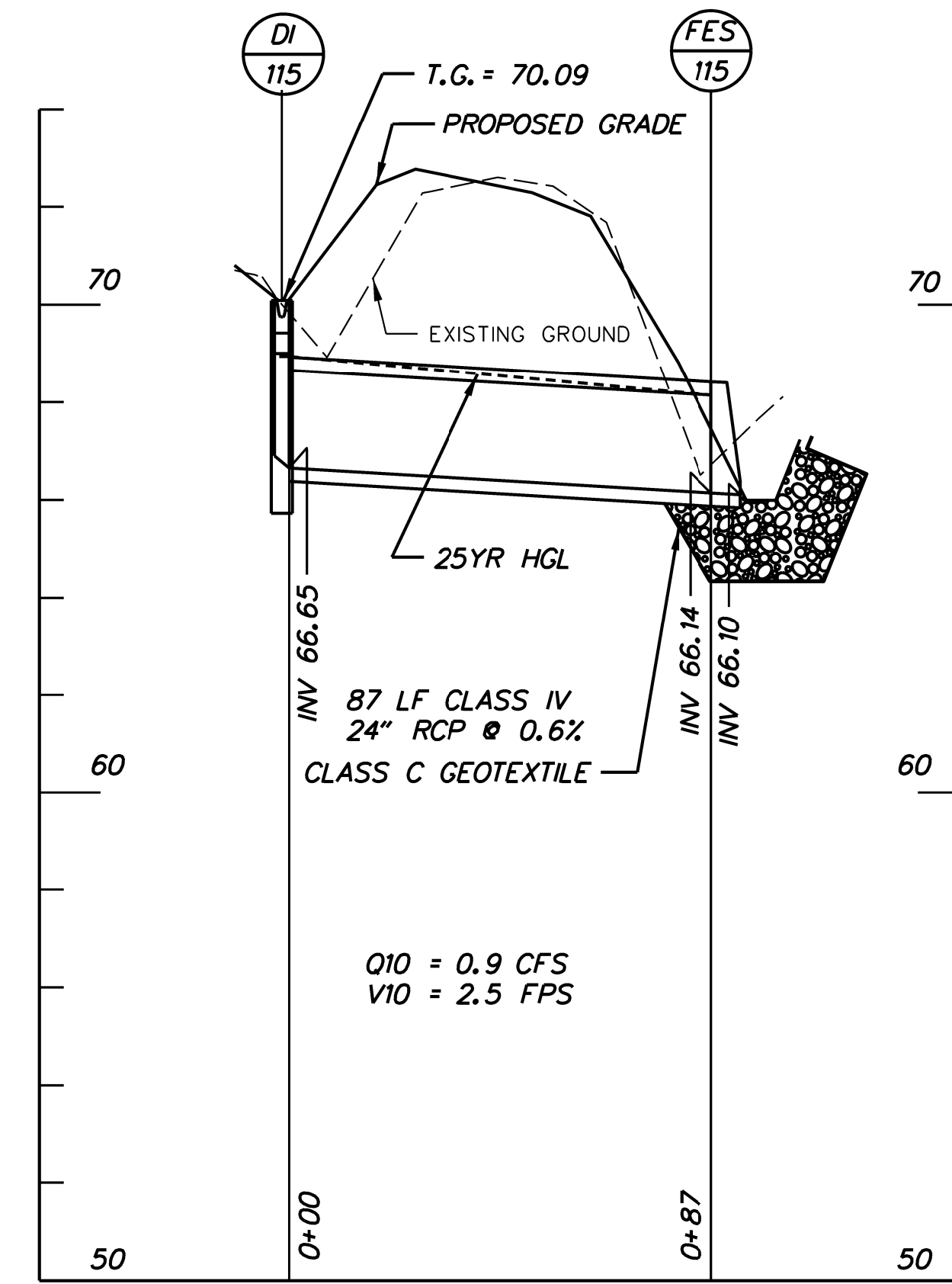

DI-115 TO FES-115

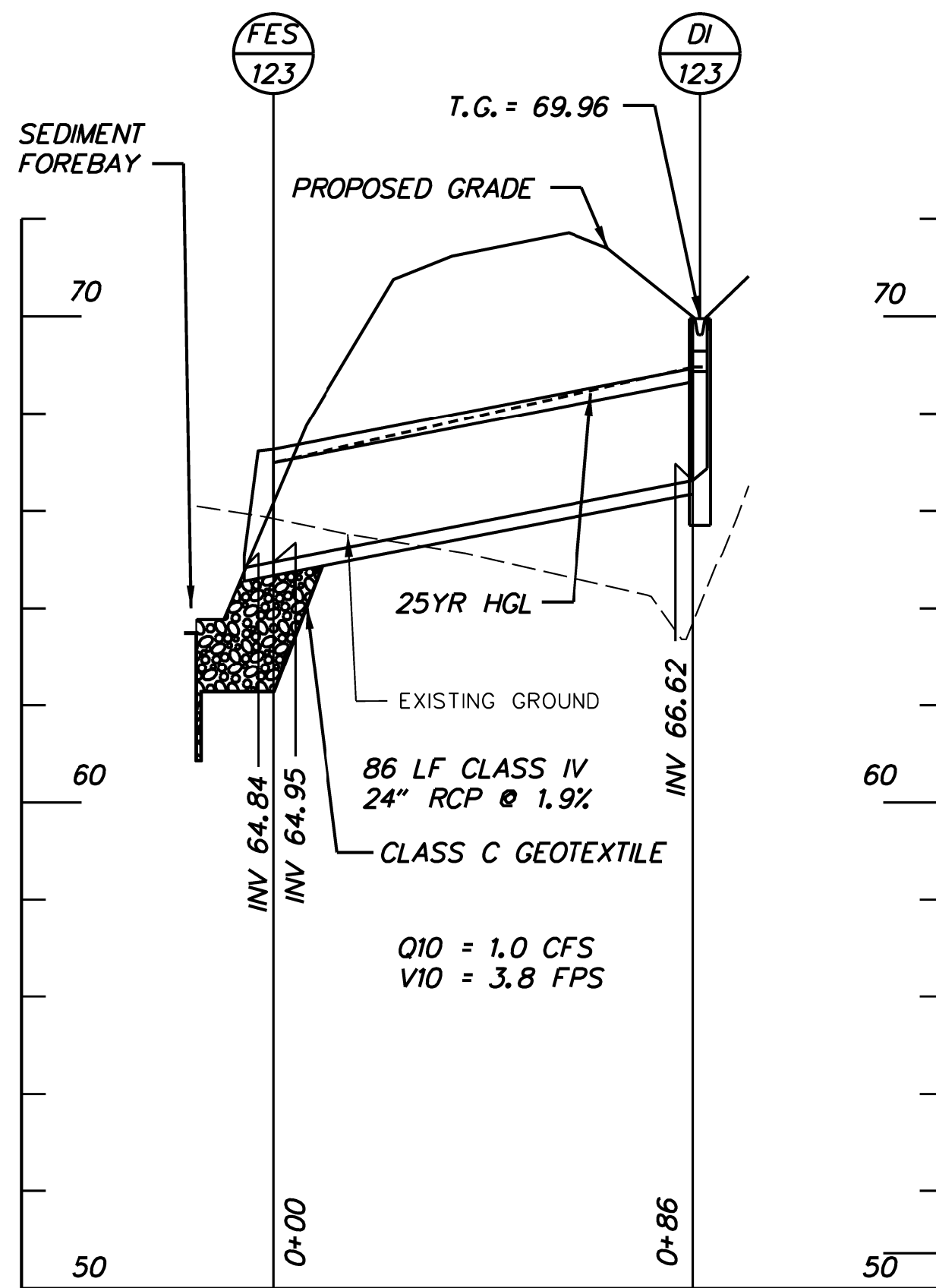

FES-123 TO DI-123

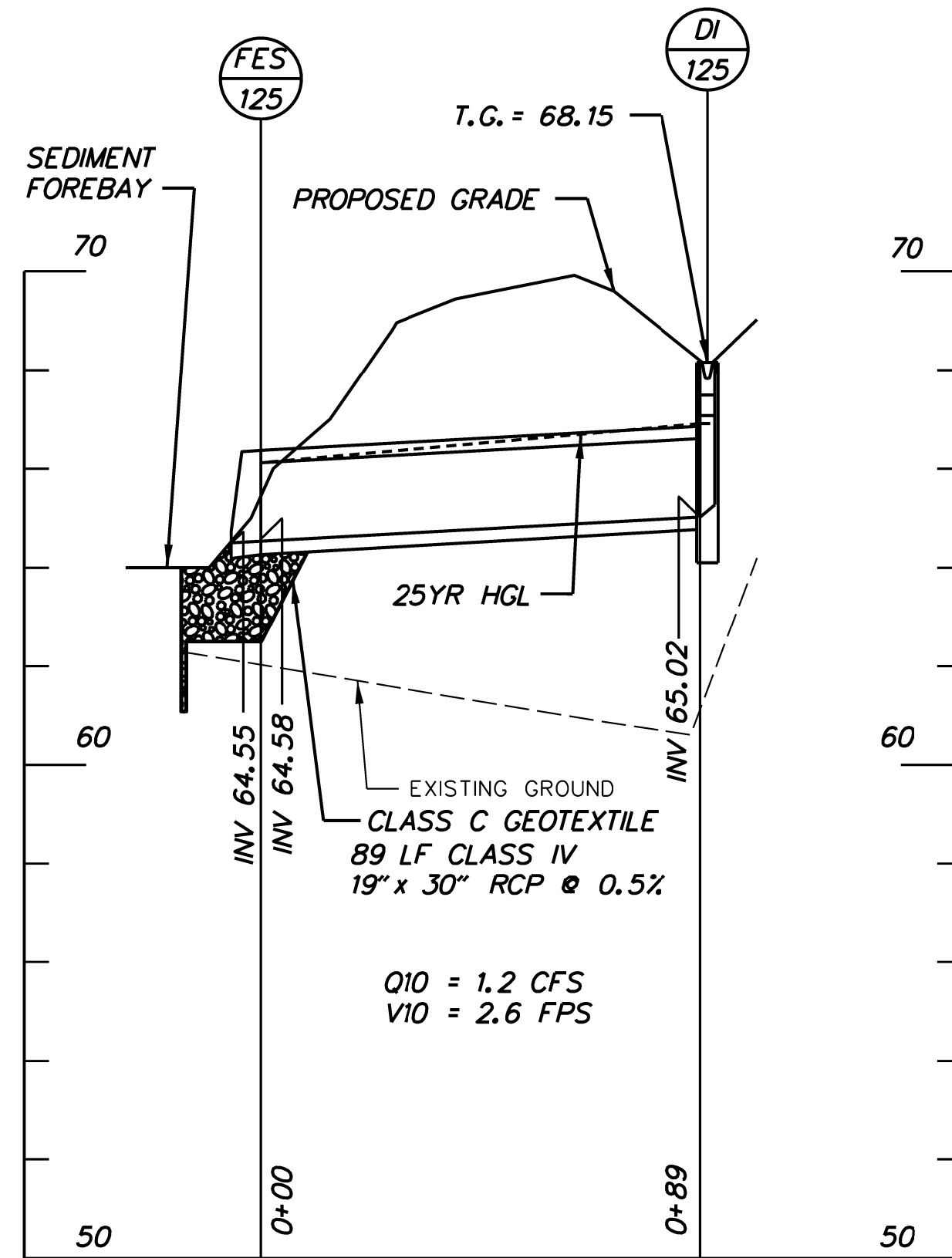

FES-125 TO DI-125

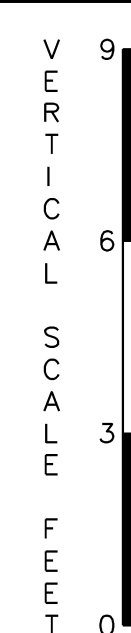

PF-57

J:\2008 PROJECTS\34801\700CADD\750AET\ROADWAY\PF MD_301D53_002.DGN

ADDENDUMS / REVISIONS	

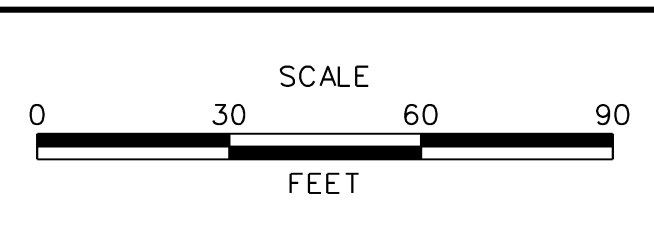

CONTRACT T200811301	BRIDGE NO.
COUNTY CECIL	DESIGNED BY: DJJ
	CHECKED BY: TC

SHEET NO.	160
TOTAL SHTS.	850